

AS-Interface (AS-i)



E84DGFCxxx

Inverter Drives 8400 motec_____

Communication Manual

EN



13444387

Contents

1	About this documentation	4
1.1	Document history	6
1.2	Conventions used	7
1.3	Terminology used	8
1.4	Notes used	9
2	Safety instructions	10
2.1	General safety and application notes	10
2.2	Device and application-specific safety instructions	11
2.3	Residual hazards	11
3	Product description	12
3.1	Application as directed	12
3.2	Features and variants	13
3.3	Connections and interfaces	14
4	Technical data	16
4.1	General data and operating conditions	16
4.2	Protocol data	17
4.3	Communication time	18
5	Installation	19
5.1	Mechanical installation	20
5.2	Electrical installation	21
5.2.1	Bus cable specification	21
5.2.2	AS-i connection	22
5.2.3	Voltage supply	23
6	Commissioning	24
6.1	Before initial switch-on	24
6.2	How to configure the host (master)	25
6.3	Settings for AS-i communication in the »Engineer«	26
6.3.1	Addressing the AS-i slaves	26
6.3.2	All parameters for setting the AS-i communication	27
6.4	Initial switch-on	28
7	Data transfer	29
7.1	AS-i messages	29
7.2	AS-i cycle	31
7.3	Synchronisation	32
7.4	AS-i concept of the Communication Unit	33
7.5	Data transmission slave 1 (AS-i profile 7.A.5)	34
7.6	Data transmission slave 2 (AS-i profile 7.A.E)	36
8	Process data transfer	38
8.1	Accessing process data / PDO mapping	39
8.2	Port interconnection of process data objects (PDO)	40

Contents

9	Parameter data transfer	43
9.1	CTT2: Read parameter value	44
9.2	CTT2: Write parameter value	45
9.3	CTT2: Read code number	46
9.4	CTT2: Write code number	47
9.5	CTT2: Block parameter transfer	48
	9.5.1 Read mode	48
	9.5.2 Write mode	50
9.6	CTT2: Standard error codes	51
9.7	CTT2: Acyclic device error codes	52
10	Diagnostics	53
10.1	LED status displays	53
10.2	Diagnostics with the »Engineer«	54
11	Error messages	55
11.1	Short overview of AS-i error messages	55
11.2	Possible causes and remedies	56
12	Parameter reference	60
12.1	Communication-relevant parameters of the operating system	60
12.2	Parameters relevant for AS-i communication	61
12.3	Table of attributes	68
	Index	70
	Your opinion is important to us	73

1 About this documentation

1 About this documentation

Contents

This documentation exclusively contains descriptions of the AS-Interface (AS-i) bus system for the Inverter Drive 8400 motec.



Note!

This documentation supplements the **mounting instructions** supplied with the Communication Unit and the **"Inverter Drives 8400 motec" hardware manual**.

The hardware manual contains safety instructions that must be observed!

The properties and functions of the AS-Interface for the Inverter Drive 8400 motec are described in detail.

Examples illustrate typical applications.

The theoretical contexts are only explained to the level of detail required to understand the function of the Communication Unit.

This documentation does not describe the software of other manufacturers. No responsibility is taken for corresponding information given in this documentation. Information on how to use the software can be obtained from the documents of the host (PLC, master).

All brand names used in this documentation are trademarks of their respective owners.



Tip!

Detailed information about the AS-Interface can be found on the website of the AS-Interface user organisation:

www.as-interface.net

1 About this documentation

Target group

This documentation addresses persons who configure, install, commission, and maintain the networking and remote servicing of a machine.



Tip!

Current documentation and software updates for Lenze products can be found in the download area at:

www.Lenze.com

Validity

The information given in this documentation is valid for the following devices:

Product series	Type designation	Version
Inverter Drives 8400 motec	E84DGFCANx	AS-i V3
Communication Unit AS-Interface	E84DGFCAXJx	AS-i V3 + Safety

▶ [Features and variants](#) (13)

Screenshots/application examples

All screenshots provided in this documentation are application examples. Depending on the firmware version of the field devices and the software version of the installed Engineering tools (»Engineer«), the screenshots in this documentation may differ from the screens.

1 About this documentation

1.1 Document history

1.1 Document history



Version			Description
1.0	12/2010	TD17	First edition
2.0	01/2011	TD17	Update: <ul style="list-style-type: none">• Low-voltage supply via the AS-i-bus cable• I/O configuration• Error messages• Parameter descriptions
3.0	01/2012	TD17	General revision
4.0	09/2013	TD17	<ul style="list-style-type: none">• General revision• New layout

1 About this documentation

1.2 Conventions used

1.2 Conventions used

This manual uses the following conventions to distinguish between different types of information:

Type of information	Writing	Examples/notes
Spelling of numbers		
Decimal	Normal spelling	Example: 1234
Decimal separator	Point	The decimal point is generally used. For example: 1234.56
Hexadecimal	0x[0 ... 9, A ... F]	Example: 0x60F4
Binary • Nibble	0b[0, 1]	Example: '0b0110' Example: '0b0110.0100'
Text		
Program name	» «	PC software Example: Lenze »Engineer«
Control element	bold	The OK button... / The Copy command... / The Properties tab... / The Name input field...
Hyperlink	<u>Underlined</u>	Optically highlighted reference to another topic. Can be activated with a mouse-click in this documentation.
Icons		
Page reference	 7	Optically highlighted reference to another page. Can be activated with a mouse-click in this documentation.
Step-by-step instructions		Step-by-step instructions are indicated by a pictograph.

1 About this documentation

1.3 Terminology used

1.3 Terminology used

Term	Meaning
AS-Interface	The AS-Interface (actuator/sensor interface) ... <ul style="list-style-type: none">• is an international standard for fieldbus communication.• is used in decentralised applications as fieldbus communication on the lowest control level.
AS-i	
Inverter	Lenze frequency inverter of the "Inverter Drives 8400 motec" product series
Standard device	
Drive Unit Communication unit Wiring Unit	The Inverter Drive 8400 motec has a modular structure. It consists of the following modules: "Drive Unit", "Communication Unit" and "Wiring Unit". <ul style="list-style-type: none">• The drive unit is available in different power settings.• The Communication Unit is available in the following versions:<ul style="list-style-type: none">• No fieldbus• AS-i option• CANopen option• PROFIBUS option• PROFINET option• EtherCAT option• EtherNet/IP option• The wiring unit provides flexible connection possibilities for a simple integration into the power supply of the machine.
»Engineer«	Lenze PC software which supports you in "engineering" (parameter setting, diagnosing, and configuring) during the entire life cycle, i.e. from planning to maintenance of the commissioned machine.
Code	Parameter which serves to parameterise or monitor the inverter. In general linguistic usage, this term is also referred to as "index".
Subcode	If a code contains several parameters, these are stored in "subcodes". In this documentation, a slash "/" is used as a separator between code and subcode (e.g. "C00118/3"). The term is usually called "subindex".
Lenze setting	This setting is the default factory setting of the device.
Basic setting	
HW	Hardware
SW	Software
CTT2 transmission (Combined Transaction Type 2)	Serial data transmission is established between master and slave (clock in/out, data in/out). This channel serves for ... <ul style="list-style-type: none">• acyclic transmission of data records;• acyclic transmission of the extended process image.
Data set transmission	In the case of CTT2 transmission, data records are transmitted between the master and the slave only on request. During acyclic data record transmission, the cyclic transmission of the extended process image is interrupted.
Process image	In the case of the Inverter Drive 8400 motec, 4 bits of control data (PAA) are transmitted to the slave every time the slave is called. The slave returns a response containing 6 bits of information (PAE). The transmission is carried out at least every 10 ms (AS-i cycle (31)), depending on the addressing assignment). In the case of extended process images, continuous transmission of 4 bytes per direction between the master and the slave takes place.
Parameter echo (diagnostics via parameter data channel)	The "Write Parameter" AS-i command serves to transmit 4 parameter bits to the slave. In the response message, the slave returns 4 bits (16 bit combinations) of status information.
ICs	Circuits which efficiently perform the described tasks of a slave.
MCU	Microcontroller
ASIC	Application specific integrated circuit

1 About this documentation

1.4 Notes used

1.4 Notes used

The following signal words and icons are used in this documentation to indicate dangers and important information:

Safety instructions

Layout of the safety instructions:



Pictograph and signal word!

(characterise the type and severity of danger)

Note

(describes the danger and gives information about how to prevent dangerous situations)

Pictograph	Signal word	Meaning
	Danger!	Danger of personal injury through dangerous electrical voltage Reference to an imminent danger that may result in death or serious personal injury if the corresponding measures are not taken.
	Danger!	Danger of personal injury through a general source of danger Reference to an imminent danger that may result in death or serious personal injury if the corresponding measures are not taken.
	Stop!	Danger of property damage Reference to a possible danger that may result in property damage if the corresponding measures are not taken.

Application notes

Pictograph	Signal word	Meaning
	Note!	Important note to ensure trouble-free operation
	Tip!	Useful tip for easy handling
		Reference to another documentation

Safety instructions

General safety and application notes

2 Safety instructions



Note!

Always observe the specified safety measures to avoid severe injury to persons and damage to material assets!

Always keep this documentation near the product during operation.

2.1 General safety and application notes



Danger!

If you ignore the following basic safety measures, severe injury to persons and damage to material assets may be caused.

- Lenze drive and automation components ...
 - must only be applied as directed.
 - ▶ [Application as directed](#) (📖 12)
 - must never be commissioned in the event of visible damage.
 - must never be technically modified.
 - must never be commissioned unless they are completely mounted.
 - must never be operated without the required covers.
 - may have live, moving, or rotary parts during and after operation, depending on the degree of protection. Surfaces may be hot.
- For Lenze drive components ...
 - only use approved accessories.
 - only use original spare parts from the manufacturer.
- Observe all specifications given in the attached and associated documentation.
 - This is a precondition for ensuring safe, trouble-free operation and for achieving the stated product features.
 - ▶ [Features and variants](#) (📖 13)
 - The procedural notes and circuit details described in this document are only proposals. It is up to the user to check whether they can be adapted to the particular applications. Lenze does not take any responsibility for the suitability of the procedures and circuit proposals described.
- Only qualified personnel may work with and on Lenze drive and automation components. According to IEC 60364 and CENELEC, these are persons ...
 - who are familiar with the installation, assembly, commissioning, and operation of the product.
 - who have the qualifications required for their occupation.
 - who know all the accident prevention regulations, directives and laws applicable on site and are able to apply them.

Safety instructions

Device and application-specific safety instructions

2.2 Device and application-specific safety instructions

- During operation, the Communication Unit must be connected to the Wiring Unit and the Drive Unit.
- Only use cables that comply with the listed specifications.
 - ▶ [Bus cable specification](#) (📖 21)



Documentation of "Inverter Drives 8400 motec", control system, plant/machine

All other measures prescribed in this documentation must also be implemented. Observe the safety instructions and application notes specified in the documentation.

2.3 Residual hazards

Device protection

- The communication unit contains electronic components that can be damaged or destroyed by electrostatic discharge.
 - ▶ [Installation](#) (📖 19)

Product description

Application as directed

3 Product description

3.1 Application as directed

The AS-Interface Communication Unit ...

- is a unit that can only be used in conjunction with the following modules:

Product series	Type designation
Inverter Drives 8400 motec Drive Unit	E84DGDVxxxxxxxx
Inverter Drives 8400 motec Wiring Unit	E84DGVNxx

- is a device intended for use in industrial power systems.
- should only be used under the operating conditions prescribed in this documentation.
- can only be used in AS-i networks.
- can also be used without being connected to the AS-i network.

Any other use shall be deemed inappropriate!

Product description

Features and variants

3.2 Features and variants

The AS-Interface Communication Unit is available in the following versions:

Product series	Type designation	Product features				
		Enclosure IP 65	AS-Interface M12	I/O: Terminal	I/O: M12	Safety
Inverter Drives 8400 motec Communication Unit AS-Interface	E84DGFCAANP	●	●	●		
	E84DGFCA9NP	●	●		●	
	E84DGFCAAJP	●	●	●		●
	E84DGFCA9JP	●	●		●	●

- The AS-Interface Communication Unit is ...
 - mounted on top of the Wiring Unit (E84DGVNxx);
 - supplied internally by the Drive Unit (E84DGDVxxxxxxx) and externally by the AS-i bus.
- The I/O connections can be brought into the device via M12 connectors or cable glands.
- Devices without an integrated safety system (safety option) have no analog input and no relay output.
- The integrated safety system can be used on machines for the protection of persons.
- The Communication Unit AS-Interface supports the services of the AS-i version 3.0:
 - cyclic reading and writing of single parameters
 - cyclic drive control
 - acyclic reading and writing of parameter sets
 - acyclic query of diagnostic data
- Two AS-i slaves are contained in the Communication Unit. Thus, two AS-i addresses are assigned. ▶ [AS-i concept of the Communication Unit \(□ 33\)](#)
- The acyclic communication via the AS-i bus and the slave 2 are available for the read and write access to parameters.
- The AS-i slaves can be addressed ...
 - via a programming unit or from the master or
 - by means of parameters (e.g. via »Engineer«, keypad or EPM).
- Up to 31 standard slaves can be connected to an AS-i network. In this case the max. cycle time is 5 ms. Up to 62 so-called A/B slaves can be connected if extended addressing is used. In this case the max. cycle time is 10 ms.
- [Synchronisation \(□ 32\)](#) of input and output data is possible.
- Communication with the Lenze »Engineer« (access to all Lenze parameters) is executed via the diagnostic interface of the Drive Unit.



"Inverter Drives 8400 motec" hardware manual

Here you will find detailed information on the integrated safety system (safety option).

Software manual / »Engineer« online help "Inverter Drives 8400 motec"

Here you will find detailed information on how to configure the safety system (safety option).

Product description

Connections and interfaces

3.3 Connections and interfaces

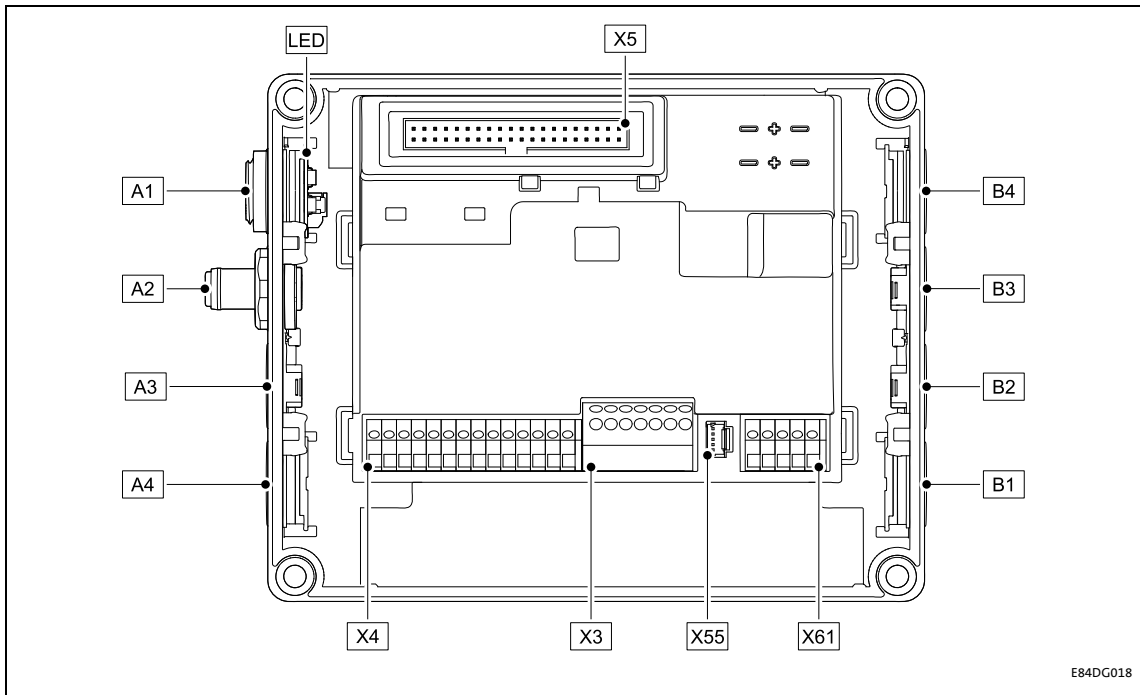

[3-1] Communication Unit AS-Interface

Pos.	Description
A1 / LED	Position of LEDs for AS-i status display ▶ LED status displays (53)
A2	AS-i terminal (M12 pins, 5-pole) ▶ AS-i connection (22)
A3 / A4	Positions for further freely designable inputs and outputs: <ul style="list-style-type: none"> • Digital inputs • Digital output • Analog input (only for E84DGFCAXJx) • Relay output (only for E84DGFCAXJx) • Connection of "Safety Option" safety system (only for E84DGFCAXJx)
B1 ... B4	
X3 / X4 / X61	Terminal strips for wiring the terminals at A2 ... A4 and B1 ... B4
X5	Plug connector for connection to the Drive Unit
X55	Plug connector for the wiring of the LEDs to A1

Product description

Connections and interfaces

- By default, the AS-i terminal and the LEDs for the AS-i status displays are already mounted and wired:
 - AS-i connection to terminal strip X3
 - LEDs on plug connector X55
- The positions A1 ... A4 and B1 ... B4 serve to freely connect the AS-i terminals, the LEDs for the AS-i status displays and other connections (e.g. digital inputs).
- For the connections, 5-pin M12 connectors or - alternatively - cable glands (cable cross-section max. 1.0 mm², AWG 18) can be used.
- The M12 connectors, cable glands and prefabricated system cables can be obtained from various manufacturers.
- Wire the M12 plugs or cable glands used with the corresponding contacts of the terminal strips X3, X4 and X61.



"Inverter Drives 8400 motec" hardware manual

Observe the notes and wiring instructions contained in this documentation.

4 Technical data



"Inverter Drives 8400 motec" hardware manual

Here you will find the **ambient conditions** and information on the **electromagnetic compatibility (EMC)** that also apply to the Communication Unit.

4.1 General data and operating conditions

Range	Values
Order designation	<ul style="list-style-type: none"> E84DGFCAXNx (AS-i V3) E84DGFCAXJx (AS-i V3, Safety)
Communication profile	AS-Interface V3.0
Standards / specifications	<ul style="list-style-type: none"> EN 50295 / IEC 62026-2 Safety engineering: EN 954-1, EN 13849-1, IEC 61508 (up to safety category 4)
Communication medium	Two-wire cable for data and auxiliary power, 2 x 1.5 mm ² (without shielding, without terminating impedance)
Interface for communication	M12 pins, 5-pole, A-coded <ul style="list-style-type: none"> Contacting of the AS-i cable with penetration technique Cable with M12 socket, 5-pole, A-coded
Max. cable length	<ul style="list-style-type: none"> Max. 100 m without repeater/extender Max. 300 m with 2 repeaters/extenders Max. 500 m only for star topology with repeater/extender
Bus termination	Only required for cable lengths > 100 m Bus terminating resistors are required at the first and last AS-i node (implemented in the connector of the bus cable)
Network topology	Free topology (line, ring, tree, star)
Type of node	Single slave or dual slave
Slave node number	<ul style="list-style-type: none"> Max. 31 standard slaves Max. 62 A/B slaves
Node address area	1 ... 31
Cycle time	<ul style="list-style-type: none"> max. 5 ms with maximum configuration 10 ms when A/B technique is used profile-specific with spec 3.0 slaves
Baud rate	167 kbps (gross) 53 kbps (net; data transfer efficiency = 32 %)
Voltage supply	External supply via AS-i bus cable <ul style="list-style-type: none"> U = 29.5 ... 31.6 V (according to AS-i specification) I_{max} = 400 mA
Available digital inputs	<ul style="list-style-type: none"> 5 dig. inputs with mains supply 4 dig. inputs with supply via AS-i bus and missing mains
Conformities, approvals	<ul style="list-style-type: none"> CE UR / cUR (see also hardware manual)

Technical data

Protocol data

4.2 Protocol data

Range	Values
AS-i device profiles	<ul style="list-style-type: none">• Slave 1: 7.A.5 (CTT2)• Slave 2: 7.A.E
Process image, standard	Slave 1: <ul style="list-style-type: none">• DI0 ... 3 = 4 bits• DO0 ... 3 = 4 bits Slave 2: <ul style="list-style-type: none">• DI0/1 = 2 bits• DO3/4 = 2 bits Total: 6 input bits / 6 output bits
Process image, A/B technique	Slave 1: <ul style="list-style-type: none">• DI0 ... 3 = 4 bits• DO0 ... 2 = 3 bits Slave 2: <ul style="list-style-type: none">• DI0/1 = 2 bits• DO3 = 1 bits Total: 6 input bits / 4 output bits
Cyclic parameter data channel (AS-i spec. V2.0 and V3.0)	4 words (8 bytes)
Acyclic parameter data channel (AS-i spec. V3.0)	max. 16 double words (64 bytes)
AS-i user data length	max. 64 bytes

4.3 Communication time

The communication time defines the time between the start of a request and the arrival of the corresponding response.

The communication times in an AS-i network depend on the ...

- processing time in the inverter;
- telegram runtime (baud rate / telegram length);
- nesting depth of the network.

Processing time in the inverter

Data	Processing time	
Process data	approx. 2 ms + 0 ... 1 ms + 1 ... x ms	Update cycle Processing time in the module Application task runtime of the use technology application (tolerance)
Parameter data	approx. 30 ms + a tolerance of 20 ms (typically) For some codes, the processing time may be longer (see software manual/ »Engineer« online help "Inverter Drives 8400 motec").	

There are no interdependencies between parameter data and process data.

5 Installation



Stop!

Electrostatic discharge

Electronic components within the Communication Unit can be damaged or destroyed by electrostatic discharge.

Possible consequences:

- The Communication Unit is defective.
- Fieldbus communication is not possible or faulty.
- I/O signals are faulty.
- The safety function is faulty.

Protective measures

Discharge electrostatic charges before touching the Communication Unit.

5.1 Mechanical installation



"Inverter Drives 8400 motec" mounting instructions

Here you will find detailed information on the installation.

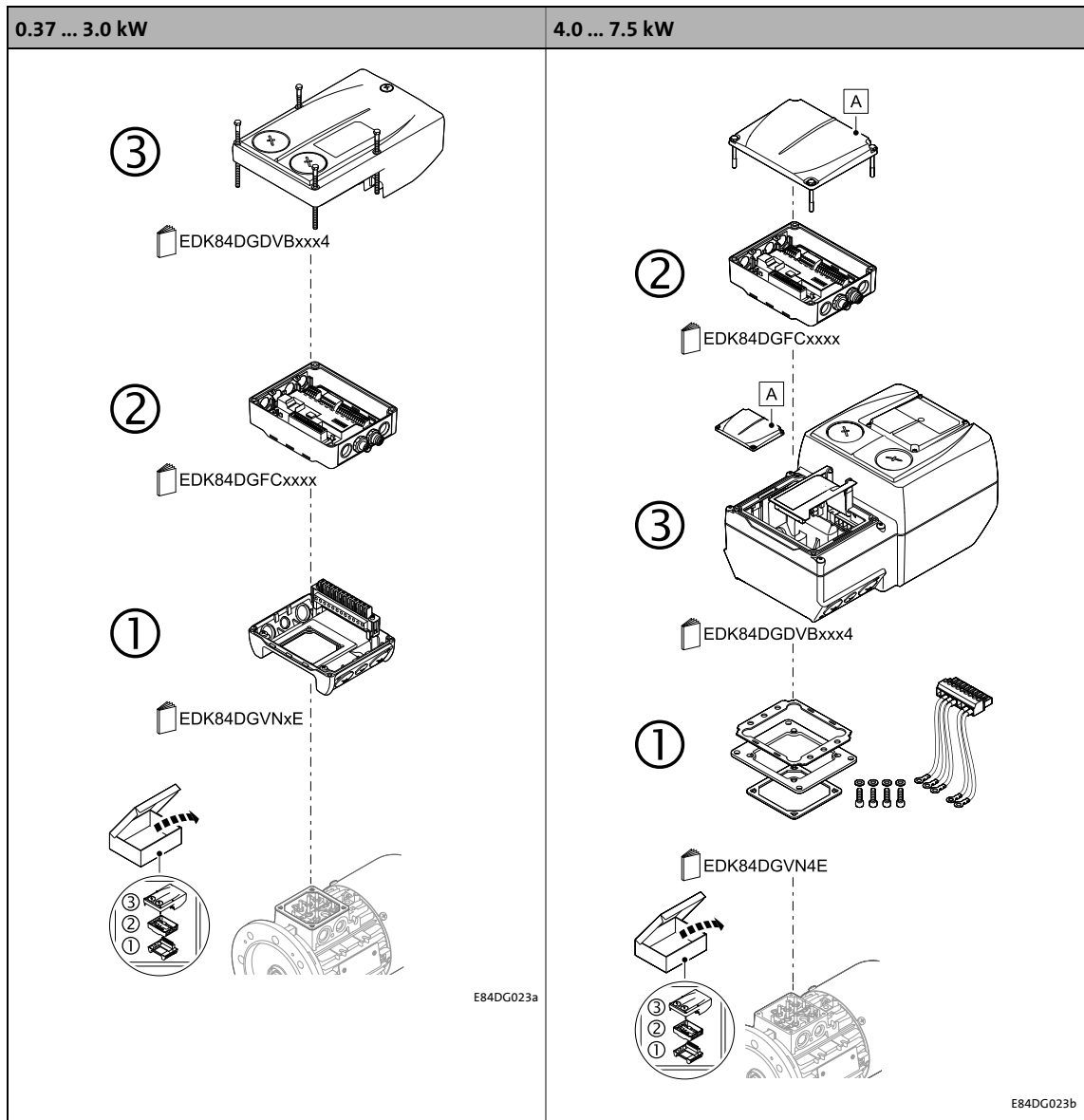

[5-1] Mechanical installation of the 8400 motec components

Legend for fig. [5-1]	
1	Drive Unit
2	Communication unit
3	Wiring Unit
A	Cover of the Drive Unit
EDK84DG...	Mounting instructions of the Drive Unit, Communication Unit, Wiring Unit

Installation

Electrical installation

5.2 Electrical installation



"Inverter Drives 8400 motec" hardware manual

Here you can find detailed information on ...

- the digital and analog inputs/outputs;
- the relay output;
- the integrated safety system (safety option);
- the wiring of the terminals.

Observe the notes and wiring instructions contained in this documentation.

5.2.1 Bus cable specification

The AS-i bus cable serves as ...

- external [Voltage supply](#) (23) of the Communication Unit;
- a means for data transmission to and from the inverter.



Note!

Only use cables that comply with the listed specifications.

Range	Values
Cable type	Two-wire cable, insulated and shielded
Core cross-section	1.5 mm ²
Cable resistance	< 90 mΩ/m, (f = 3 ... 20 MHz)
Inductance	400 ... 1300 nH/m
Capacitance per unit length	< 80 pF/m
Electrical master value	< 5 μS/m
Surge impedance	70 ... 140 Ω
Group runtime	< 8.3 ns/m



Tip!

These data are also met by several other standardised cables. An AS-i network can also be set up with different cables. Multi-core cables (e.g. DeviceNet Thick Cable, DESINA cable/light conductor) or busbars can be used for the setup of AS-i networks, too. In case of doubt, consult a specialist in the planning phase.

Prefabricated system cables can be obtained from diverse manufacturers.

Installation

Electrical installation

5.2.2 AS-i connection

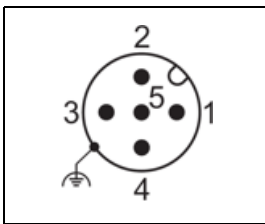

- M12 pins, 5-pole, A-coded
- Wiring of terminal strip X3

AS-i connection		
Pin	Signal	Description
1	ASi+	AS-i data line, positive
2	-	Not assigned
3	ASi-	AS-i data line, negative
4	-	Not assigned
5	-	Not assigned

5.2.3 Voltage supply

- The Communication Unit is supplied with voltage via the AS-i bus cable.
- Access to parameters of a device that is disconnected from the mains is not possible.
- Permissible voltage (DC) / max. current:
 - $U = 29.5 \dots 31.6 \text{ V}$ (according to AS-i specification)
 - $I_{\text{max}} = 400 \text{ mA}$

Low-voltage supply via the AS-i-bus cable

In case of low-voltage supply via the AS-i bus cable, communication with the slaves is still possible if no mains voltage is available.

- A previous mains connection (400 V) is not required.
- The digital inputs DI1 ... DI5, RFR and the analog input can still be evaluated.
- The AS-i input ports DI0 ... DI3 represent the digital inputs DI1 ... DI4 (see [AS-i concept of the Communication Unit \(□ 33\)](#)). The current status of these inputs can be called.
- All digital input and output data which can be selected by the inverter are deleted or invalid..
- External sensors are also supplied via the AS-i bus cable.



"Inverter Drives 8400 motec" hardware manual

Here you can find detailed information on how to wire the Communication Unit.

Commissioning

Before initial switch-on

6 Commissioning

During commissioning, system-related data such as motor parameters, operating parameters, responses, and parameters for fieldbus communication are defined for the drive. For Lenze devices, this is done via the codes.

The codes of the drive and communication are saved non-volatilely as a data set in the memory module.

In addition to codes for the configuration, there are codes for diagnosing and monitoring the nodes.

▶ [Parameter reference](#) (□ 60)

6.1 Before initial switch-on



Stop!

Before you switch on the inverter for the first time, check the entire wiring for completeness, short circuit, and earth fault.

Commissioning

How to configure the host (master)

6.2 How to configure the host (master)

For communication with the inverter, the host (master) must be configured first.

Defining the user data length

- The AS-Interface Communication Unit supports the configuration of max. 8 process data words (max. 64 bytes).
- The user data length is defined during the initialisation phase of the master.
- The user data lengths for process input data and process output data are identical.



Note!

Observe the direction of the information flow.

- Process input data (Rx data):
Process data from the inverter (slave) to the host (master)
- Process output data (Tx data):
Process data from the host (master) to the inverter (slave)

Commissioning

Settings for AS-i communication in the »Engineer«

6.3 Settings for AS-i communication in the »Engineer«

6.3.1 Addressing the AS-i slaves

Addressing is usually carried out automatically via the master or an external addressing unit.

The AS-Interface Communication Unit uses two slaves (see [AS-i concept of the Communication Unit \(33\)](#)) which must be initialised with **unique addresses**.



Note!

- If the same address is used for slave 1 and slave 2, the address of slave 2 is set to '0'.
- If address '0' is assigned to slave 1 and slave 2, slave 2 is switched "offline" (basic settings remain intact).
- The setting [C13200/x](#) / [C13202/x](#) = 64 serves to deactivate the slave (not active or visible in the AS-i network).

The parameters for addressing the AS-i slaves can be found in the »Engineer« on the "Settings" tab.

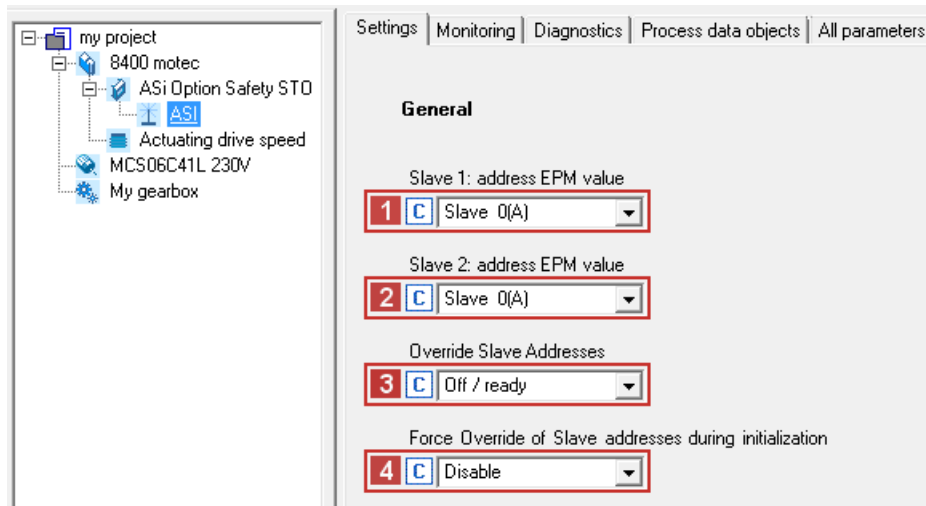

Setting / parameters	Code
1 Slave 1: Address EPM value	C13202/1
2 Slave 1: Address EPM value	C13202/2
3 Override slave addresses	C13204
4 Override of the slave addresses during initialisation	C13205

Commissioning

Settings for AS-i communication in the »Engineer«

6.3.2 All parameters for setting the AS-i communication

All parameters for setting the AS-i communication can be found in the »Engineer« on the "All parameters" tab.

ID	C...	S	Name	Value
13200	1		Slave 1: Active address	Slave 0(A)
13200	2		Slave 2: Active address	Slave 0(A)
13202	1		Slave 1: address EPM value	Slave 0(A)
13202	2		Slave 2: address EPM value	Slave 0(A)
13204	0		Override Slave Addresses	Off / ready
13205	0		Force Override of Slave addresses during initialization	Disable
13206	1		Slave 1 Profile	0x0000
13206	2		Slave 2 Profile	0x0000
13207	1		Slave 1 communication timeout	Fault
13207	2		Slave 1 communication timeout - CTT2 Extendet cyclic	Fault
13207	3		Slave 2 communication timeout	Fault

Save the changed settings with the device command **C00002/11** (save all parameter sets).

- ▶ [Addressing the AS-i slaves](#) (📖 26)
- ▶ [Parameters relevant for AS-i communication](#) (📖 61)

6.4 Initial switch-on

Establishing communication

- To establish a communication, the Inverter Drive must be supplied with mains voltage.
- For AS-i communication, the Communication Unit has to be supplied with voltage. If this is not the case, the error message "CE04: MCI communication error" (error no. 01.0127.00002) is output.
- The [Voltage supply](#) (□ 23) via the AS-i bus cable serves to maintain the AS-i communication in case of a main supply failure.
- During mains connection, all parameters (codes) are read.
- Addressing can be carried out automatically via the master, an external addressing unit or manually via codes in the »Engineer«.
 - ▶ [Addressing the AS-i slaves](#) (□ 26)

Data transfer

AS-i messages

7 Data transfer

The AS-Interface transmits parameter data, configuration data, diagnostic data, alarm messages and process data between the host (master) and the inverters (slaves) participating in the fieldbus. Depending on their time-critical nature, the data are transmitted via different communication channels.

The bus access method of the AS-Interface is a master-slave method with cyclic polling.

- The master transmits a frame (master call) with a specific slave address.
- The slave triggered with this address responds within the allowed time (acknowledgement of the message).
- When the response has been received correctly from the master, the message is deemed to be transmitted successfully.
- If the master does not receive any response or the response cannot be decoded without errors for the master, the frame can be repeated.

7.1 AS-i messages

An AS-i message consists of ... a master call, a short pause, a slave response, and a short pause again.

Master call	Pause 1	Slave response	Pause 2
14 bits		7 bits	
84 μ s	16 μ s	42 μ s	9 ... 12 μ s
151 ... 154 μ s			

- All master calls have a length of 14 bit times (1 bit time = 6 μ s).
- All slave responses have a length of 7 bit times.
- The 1st pause has a typical duration of 16 μ s (synchronised slave) and must not be longer than the expected slave response.
If during this time the master does not receive the start of a slave response, no response will arrive anymore. Now the master may start with the next call.
- At the end of the slave response, there is a short pause again with a typical duration of approx. 9 ... 12 μ s.
The master needs this time to check the slave response and decide what should happen next (repeat the transmitted call or continue with the next call).

Broadcast call of the master

An exception to this message structure is a broadcast request of the master. A broadcast transmission corresponds to broadcasting to all nodes (simultaneous transmission from the master to all slaves). It can only be effected in one direction. Broadcast transmissions cannot be acknowledged. Hence, it is not ensured that all slaves have received the message correctly.

Data transfer

AS-i messages

Structure of the master call

Structure in the **standard addressing mode** for up to 31 slaves:

ST	SB	Address	Information	PB	EB
1 bit	1 bit	5 bits	5 bits	1 bit	1 bit

Structure in the **advanced addressing mode** for up to 62 slaves:

ST	SB	Address	Information	PB	EB	
1 bit	1 bit	5 bits	1 bit Select bit	3 bits	1 bit	1 bit

Bit field	Description
ST	The start bit marks the start of the master call. <ul style="list-style-type: none"> • 0: Valid start bit • 1: Not permitted
SB	The control bit designates the call of data, parameters, addressing or commands. <ul style="list-style-type: none"> • 0: Data/parameter/addressing call • 1: Command call
Address	<ul style="list-style-type: none"> • 5 address bits contain the address of the slave to be called. • Valid address range: 1 ... 31
Information	Depending on the call type, the information bits contain the information that is transmitted to the slave. <ul style="list-style-type: none"> • 5 information bits in standard addressing mode • 4 information bits in advanced addressing mode Advanced addressing mode: <ul style="list-style-type: none"> • For the advanced addressing mode (for up to 62 slaves), an additional select bit has been defined. • This has been defined in order that an A slave behaves the same as a standard slave. An A slave can also be operated in networks where the master cannot distinguish between A and B slaves. A/B slaves can be recognised by the hexadecimal ID code "0xA". • Valid address range: 1A ... 31A, 1B ... 31B
PB	Parity bit: The sum of all 1 bit states in the master call must be even.
EB	The end bit marks the end of the master call. <ul style="list-style-type: none"> • 0: Not permitted • 1: Valid end bit

Structure of the slave response

ST	Information	PB	EB
1 bit	4 bits	1 bit	1 bit

Bit field	Description
ST	The start bit marks the start of the slave response. <ul style="list-style-type: none"> • 0: Valid start bit • 1: Not permitted
Information	The 4 information bits contain the information that is transmitted to the master.
PB	Parity bit: The sum of all 1 bit states in the slave response must be even.
EB	The end bit marks the end of the slave response. <ul style="list-style-type: none"> • 0: Not permitted • 1: Valid end bit

Data transfer

AS-i cycle

7.2 AS-i cycle

The complete AS-i cycle consists of:

- AS-i messages
Max. 31 messages (sum of the standard slaves connected to the network or the maximum of A and B slaves)
- 1 management call
Consists of a parameter exchange or a command to a slave and an optional response.
- 1 call from the recording phase
Search for new slave addresses and optional response
- 1 reserve message (if required)

Cycle time

- The cycle time results from the following formula:

$$\text{Cycle time} = \text{messages per cycle} \times \text{max. message duration}$$

- When the maximum cycle time is determined, 33 messages are maximally estimated. Hence:

$$\text{Max. cycle time} = 33 \text{ messages} \times 154 \mu\text{s} = 5.08 \text{ ms}$$

- Thus, approx. 200 cycles are passed per second.
- Thus, a standard slave can be provided 200 times per second with new output data and can transmit its input data to the master.



Note!

Wherever A and B slaves are operated on one address, the cycle time is twice as long.

Medium response time

- The medium response time results from the following formula:

$$\text{Medium response time} = 0.5 \times \text{max. cycle time} + \text{max. message duration}$$

$$\text{Medium response time} = 0.5 \times 5.08 \text{ ms} + 154 \mu\text{s} = 2.7 \text{ ms}$$

- The **jitter**, which is the fluctuation around the medium response time, amounts to ...
 - $\pm 2.5 \text{ ms}$ for standard slaves;
 - $\pm 5.0 \text{ ms}$ for A/B slaves.



Note!

Wherever A and B slaves are operated on one address, the medium response time is twice as long (5.4 ms).

7.3 Synchronisation

The synchronisation serves to read in or output all input and output data exactly at the same time and independent of the slave address. The jitter of the outputs can be reduced from ± 2.5 ms to ± 154 μ s.

In a standard data exchange, the outputs of each slave that receives a data call from the master are updated immediately and the input information are read in. For the 1st slave, this occurs approx. 154 μ s before the 2nd slave and for this slave again approx. 154 μ s before the 3rd etc.

If all the slaves are in a synchronised state, the information at their inputs and outputs is only synchronised once at the beginning of the cycle. Since each slave can recognise when a new AS-i cycle starts, no special additional synchronisation command is required. Thus, the information exchange within the cycle remains the same. In order that the synchronisation works, not every slave has to be in a synchronised state.

Data transfer

AS-i concept of the Communication Unit

7.4 AS-i concept of the Communication Unit

The AS-Interface Communication Unit supports the following device profiles:

AS-i profile	Slave	Data transmission	Data / parameter bits
7.A.5	1	Cyclic process image	DI0/1, DO2/3
		Serial data transmission (CTT2): Acyclic transmission of data records and cyclic transmission of the extended process image ▶ Extended process image for slave 1 (35)	DI2/3, DO0/1
7.A.E	2	Cyclic process image	DI0 ... 3, DO0 ... 3
		Diagnostics via parameter data channel (parameter echo)	P0 ... P3

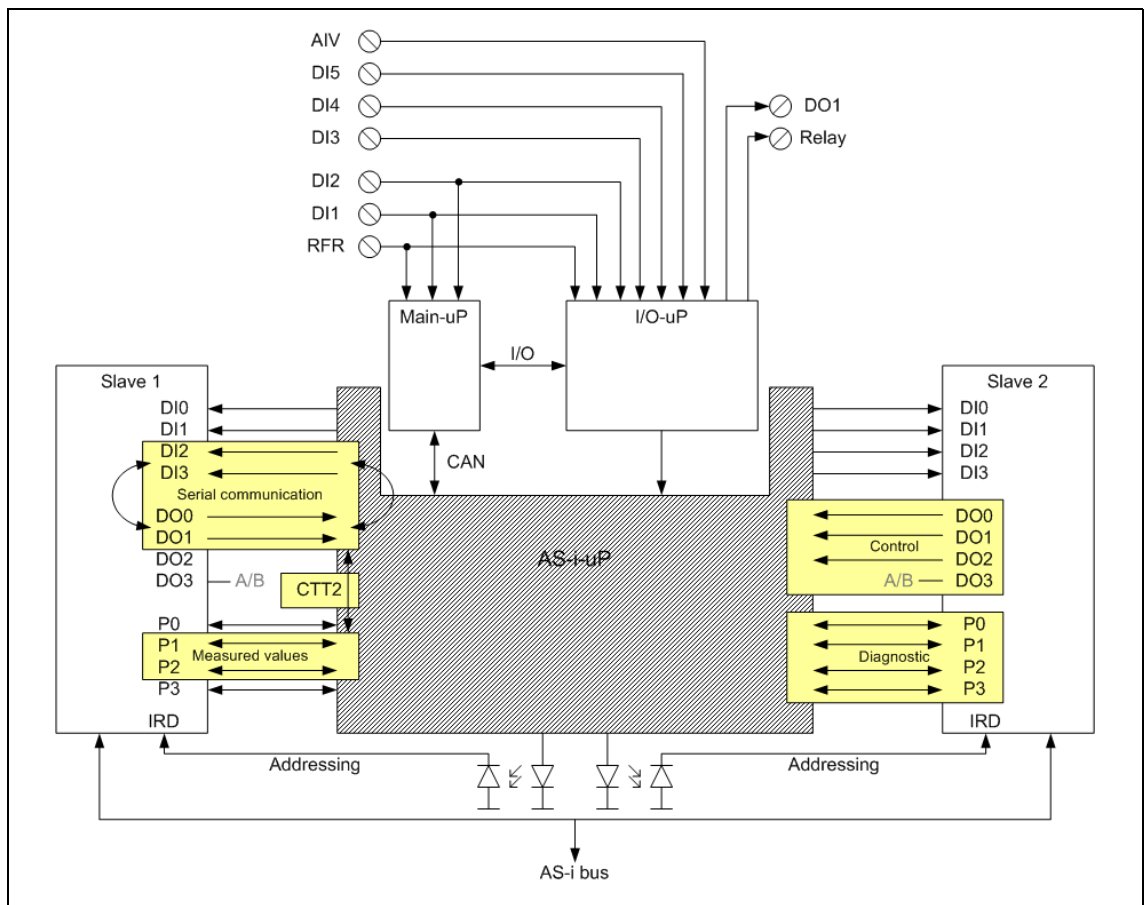

[7-1] AS-i concept of the Communication Unit

Data transfer

Data transmission slave 1 (AS-i profile 7.A.5)

7.5 Data transmission slave 1 (AS-i profile 7.A.5)

Accessing the data bits

Bits	Signal / I/O mapping	Description / standard connection with ...
Inputs		
DI0	DigIn_bIn2	The function of these inputs cannot be selected in the »Engineer«. Can be used to monitor the digital inputs if the Drive Unit is in the "offline" status.
DI1	DigIn_bIn4	
DI2	Serial Clock In	Intended for CTT2 transmission.
DI3	Serial Data In	
Outputs		
DO0	Serial Clock Out	Intended for CTT2 transmission.
DO1	Serial Data Out	
DO2	LP_Network_In: MCI_bCtrl_B3	C00701/3: not connected
DO3	Reserved	Reserved for AS-i A/B addressing

Accessing the parameter bits

Bits	Signal / I/O mapping	Description
P0	Reserved	Selection of the process image: <ul style="list-style-type: none">• 0: Data of the extended (cyclic) process image 1• 1: Data of the extended (cyclic) process image 2 ▶ Extended process image for slave 1 (□ 35)
P1	Reserved	
P2	Reserved	
P3	Reserved	Reserved for AS-i A/B addressing

Data transfer

Data transmission slave 1 (AS-i profile 7.A.5)

Extended process image for slave 1

Extended process image 1 - PR0 = 0

Position	Signal / I/O mapping
Master → Slave (2 x 16 bits/word)	
Word 1	MCI_wIn2/CAN1_wIn2
Word 2	MCI_wIn5/CAN2_wIn1
Slave → Master (2 x 16 bits/word)	
Word 1	MCI_wOut2/CAN1_wOut2
Word 2	MCI_wOut5/CAN2_wOut1

Extended process image 2 - PR0 = 1

Position	Signal / I/O mapping	Description
Master → Slave (2 x 16 bits/word)		
Word 1	MCI_wIn2/CAN1_wIn2	
Word 2	MCI_wIn5/CAN2_wIn1	
Slave → Master (2 x 16 bits/word)		
Word 1	MCI_wOut2/CAN1_wOut2	
Word 2: Bits 0 ... 9	0 ... 10 V (Voltage at analog input)	10 V = 1000
Word 2: Bit 10	DI3	0: Active 1: Not active
Word 2: Bit 11	DI4	
Word 2: Bit 12	DI5	
Word 2: Bit 13	Reserved	
Word 2: Bit 14	I/O status information	0: Invalid data in word 1, word 2 1: Valid data in word 1, word 2
Word 2: Bit 15	Status of the drive (Drive Unit)	0: Drive (Drive Unit) is "offline" 1: Drive (Drive Unit) is "online"

Data transfer

Data transmission slave 2 (AS-i profile 7.A.E)

7.6 Data transmission slave 2 (AS-i profile 7.A.E)

Accessing the data bits

Bits	Signal / I/O mapping	Description / standard connection with ...
Inputs		
DI0	LP_Network_Out: MCI_bState_B0	C00621/30: not connected
DI1	LP_Network_Out: MCI_bState_B1	C00621/31: not connected
DI2	Digin_bIn1	The function of these inputs cannot be selected in the »Engineer«. Can be used to monitor the digital inputs if the Drive Unit is in the "offline" status.
DI3	Digin_bIn3	
Outputs		
DO0	LP_Network_In: MCI_bCtrl_B0	C00701/1: not connected
DO1	LP_Network_In: MCI_bCtrl_B1	C00701/6: not connected
DO2	LP_Network_In: MCI_bCtrl_B2	C00701/5: not connected
DO3	Reserved	Reserved for AS-i A/B addressing

Data transfer

Data transmission slave 2 (AS-i profile 7.A.E)

Accessing the parameter bits

Parameter bits P0 ... P3 provide diagnostic information to the master for slave 2. Here, P0 ... P2 define whether a status query of code **C00150** or an error/warning diagnostics is returned as slave response to the master.

The values of P0 ... P3 are transmitted to the master via the "Write_Parameter" command.

Bits	Signal / I/O mapping	Description
P0	Diagnostic information (slave → master): <ul style="list-style-type: none"> • 4 status bits of the status word C00150 • Error messages / warnings (see below) 	Values P0 - P1 - P2: <ul style="list-style-type: none"> • 0 - 0 - 0: Query C00150/Bits 0 ... 3 • 0 - 0 - 1: Query C00150/Bits 4 ... 7 • 0 - 1 - 0: Query C00150/Bits 8 ... 11 • 0 - 1 - 1: Query C00150/Bits 12 ... 15 • 1 - 0 - 0: Active error • 1 - 0 - 1: Active warning
P1		
P2		
P3		

Error messages and warnings



Note!

No error message / warning is ever provided other than the one with the highest priority. As long as this error message / warning is pending, no other can be provided.

Values				Error message	Warning
P0	P1	P2	P3		
0	0	0	0	No failure	No warning
0	0	0	1	"OC1" - Short circuit	"OC5" - Device load warning
0	0	1	0	"OC2" - Ground fault	"OC6" - Overload warning
0	0	1	1	"OH" - High temperature	Heat sink temperature high warning
0	1	0	0	"US02" - User error #1	"US01" - User warning #1
0	1	0	1	"OU" - High bus voltage	Brake resistor overload
0	1	1	0	"LU" - Low bus voltage error	"LU" - Low bus voltage warning
0	1	1	1	"OC6" - Overload error	Motor identification active
1	0	0	0	"Su02" - Single phasing	"Su02" - Single phasing
1	0	0	1	"US02" - User error #2	"US02" - User warning #2
1	0	1	0	"dbF" - Dynamic brake fault	AutoStartLock
1	0	1	1	"PS0x" - EPM failure	Motor phase failure
1	1	0	0	"DF0x" - Internal failure	AIN current < 4 mA
1	1	0	1	"OH3" - PTC fault	Reserved (unused)
1	1	1	0	Drive Unit "offline"	Reserved (unused)
1	1	1	1	Other failure	Other warnings

8 Process data transfer

- Process data are transmitted via the process data channel.
- The process data serve to control the inverter.
- The transmission of process data is time-critical.
- Process data are cyclically transferred between the master and the slaves participating in the fieldbus (continuous exchange of current input and output data).
- The master can directly access the process data. In the PLC, for instance, the data are directly assigned to the I/O area.
- Process data are not saved in the inverter.
- Process data are e.g. setpoints, actual values, control words, and status words.



Note!

Observe the direction of the information flow.

- Process input data (Rx data):
Process data from the inverter (slave) to the host (master)
- Process output data (Tx data):
Process data from the host (master) to the inverter (slave)

Process data transfer

Accessing process data / PDO mapping

8.1 Accessing process data / PDO mapping

Process data are transferred via the MCI/CAN interface.

- The process data is accessed via the **LP_Network_In** and **LP_Network_Out** port blocks.
- Up to 8 words (16 bits/word) per direction can be exchanged.
- The port/function blocks of the process data objects (PDO) are interconnected via the Lenze »Engineer«.

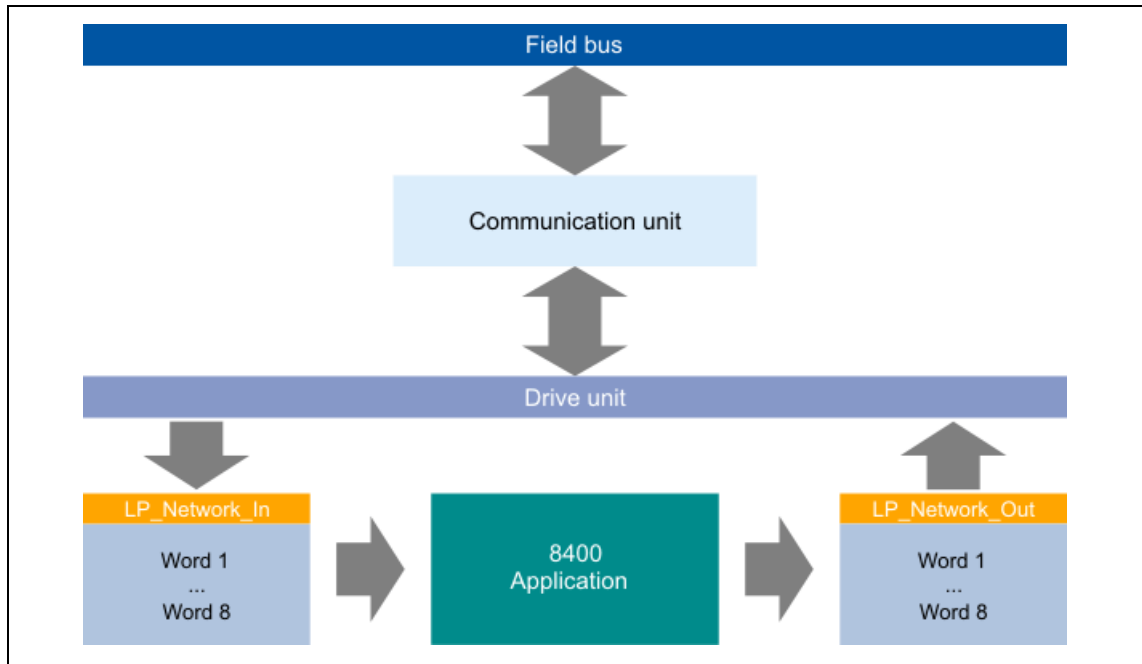

[8-1] Outer and inner data transfer between bus system, drive and application



Software manual / »Engineer« online help for the Inverter Drive 8400 motec

Here you will find detailed information on the port/function block interconnection in the »Engineer« and on the port blocks.

Process data transfer

Port interconnection of process data objects (PDO)

8.2 Port interconnection of process data objects (PDO)



How to configure the port interconnection in the »Engineer«:

1. Go to the **Application parameters** tab to make the default setting of the I/O configuration. Select the **"Network (ASi)"** control mode (C00007).

2. The **Process data objects** tab of the AS-i interface displays the preset I/O configuration.

Process data transfer

Port interconnection of process data objects (PDO)

3. Open the "Assignment Signal --> Function Block" dialog window using the [...] buttons. Here, tick (✓) the signals that are sent from the PLC (AS-i master) to the inverter.

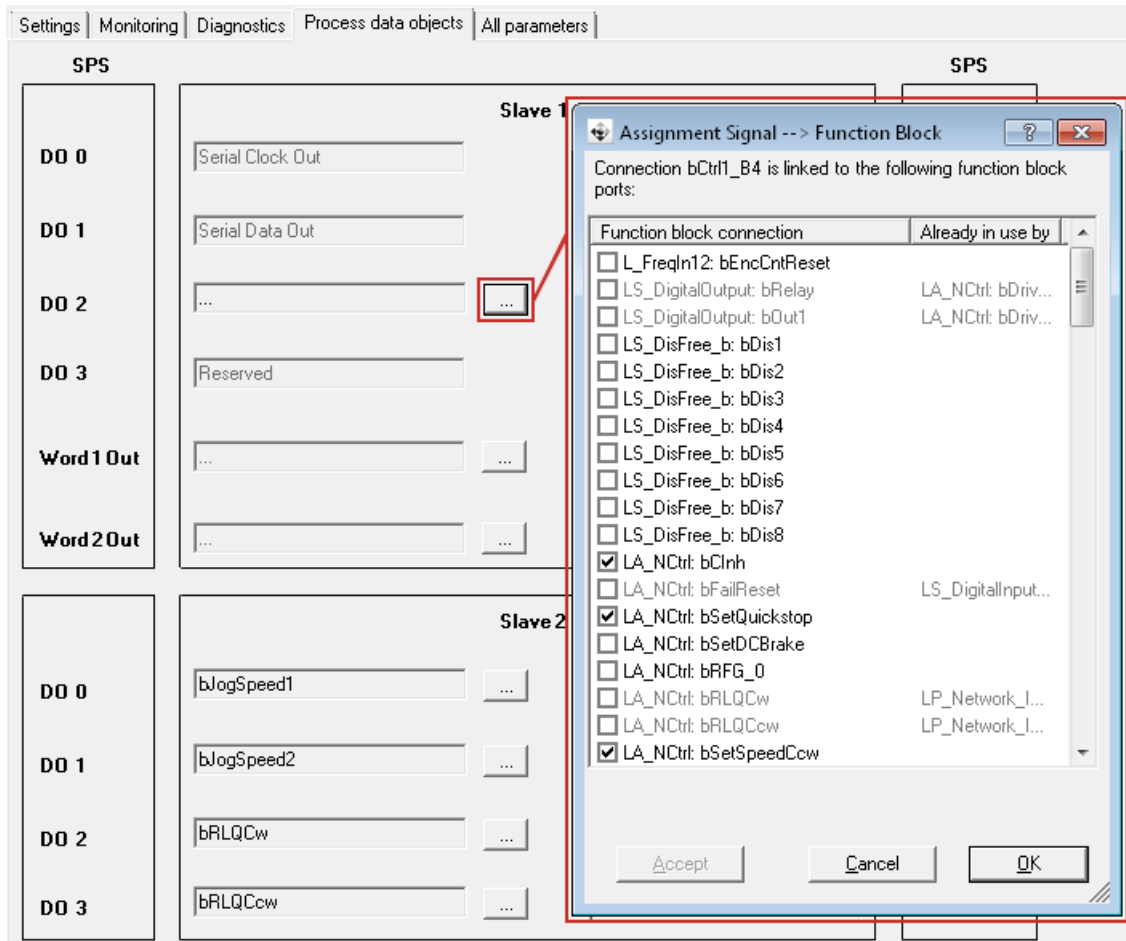

4. Confirm the selection with OK.

Process data transfer

Port interconnection of process data objects (PDO)

5. The codes **1 C00620/21**, **2 C00620/24**, **3 C00621/30** and **4 C00621/31** serve to select the signals that are sent from the inverter to the PLC (AS-i master).

Settings | Monitoring | Diagnostics | **Process data objects** | All parameters

SPS		Slave 1		SPS	
DO 0	Serial Clock Out		DigIn-bln 2 (fix)	DI 0	
DO 1	Serial Data Out		DigIn-bln 4 (fix)	DI 1	
DO 2	bSetSpeedCcw; bSetQuickstop; b...	...	Serial Clock In	DI 2	
DO 3	Reserved		Serial Data In	DI 3	
Word1 Out	MCI_wOut2/CAN1_wOut2	Word1In	
			1 C Not connected		
Word2 Out	MCI_wOut5/CAN2_wOut1	Word2In	
			2 C Not connected		
SPS		Slave 2		SPS	
DO 0	bLogSpeed1	...	MCI_bState_B0/CAN1_bState...	DI 0	
			3 C LS_ParFix: bTrue		
DO 1	bLogSpeed2	...	MCI_bState_B1/CAN1_bState...	DI 1	
			4 C LA_NCtrl: bDriveReady		
DO 2	bRLQCw	...	DigIn-bln 1 (fix)	DI 2	
DO 3	bRLQCcw	...	DigIn-bln 3 (fix)	DI 3	

6. Use code **C00002** to execute the command **"11: Save all parameter sets"**.
The changed settings are activated and saved safe against mains failure.

9 Parameter data transfer

- Parameter data are acyclically transmitted via the parameter data channel.
- The parameter data channel provides access to all Lenze codes.
- In general, the transmission of parameter data is not time-critical.
- Parameter data are, for instance, operating parameters, diagnostic information, and motor data.
- Parameter data transfer of the AS-Interface Communication Unit is done acyclically by means of serial CTT2 transmission (combined transaction type 2).

Parameter data transfer

CTT2: Read parameter value

9.1 CTT2: Read parameter value

- Acyclic read request from the master to the slave:

Byte	Contents / value
0	CTT2: Code <ul style="list-style-type: none">• Index 0x12 (18): Acyclic read request
1	CTT2: Index <ul style="list-style-type: none">• Index 0x10 (16): Read parameter value
2	CTT2: Number of bytes <ul style="list-style-type: none">• Value depends on the master.

- Response from slave to master is OK:

Byte	Contents / value
0	CTT2: Code <ul style="list-style-type: none">• Index 0x52 (82): Acyclic read request is OK.
1	Data type / number of bytes <ul style="list-style-type: none">Bit 7 = 0: Octet string (text)<ul style="list-style-type: none">• Bits 0 ... 6 = Number of string charactersBit 7 = 1: Number (4 data bytes):<ul style="list-style-type: none">• Bits 0 ... 2 = Number of valid bytes (1 = 1 byte, 2 = 2 bytes, 3 = 3 bytes, 4 = 4 bytes)
2	1st character of the character string or data byte 1 (MSB)
3	2nd character of the string or data byte 2
4	3rd character of the string or data byte 3
5	4th character of the string or data byte 4 (LSB)
6	5th character of the string
...	...
n	n-th character of the string

- Response from slave to master has failed:

Byte	Contents / value
0	CTT2: Code <ul style="list-style-type: none">• Index 0x92 (146): Acyclic read request is not OK.
1	CTT2: Standard error code <ul style="list-style-type: none">▶ CTT2: Standard error codes (📖 51)
2	Error code (MSB)
3	Error code
4	Error code
5	Error code (LSB) <ul style="list-style-type: none">▶ CTT2: Acyclic device error codes (📖 52)

Parameter data transfer

CTT2: Write parameter value

9.2 CTT2: Write parameter value

- Acyclic write request from master to slave:

Byte	Contents / value	
0	CTT2: Code • Index 0x13 (19): Acyclic write request	
1	CTT2: Index • Index 0x18 (24): Write parameter value	
2	CTT2: Number of bytes • 0x8 (8)	
3	Index high byte	Index = 0x5FFF (code to be written)
4	Index low byte	
5	Subindex	
6	Data type / number of bytes	
	Bit 7 = 0	Number (4 data bytes): • Bits 0 ... 2 = Number of valid bytes (1 = 1 byte, 2 = 2 bytes, 3 = 3 bytes, 4 = 4 bytes)
	Bit 7 must be "0". Writing the string is not supported.	
7	Data byte 1 (MSB)	
8	Data byte 2	
9	Data byte 3	
10	Data byte 4 (LSB)	

- Response from slave to master is OK:

Byte	Contents / value
0	CTT2: Code • Index 0x53 (83): Acyclic write request is OK. • Parameter value was written.

- Response from slave to master has failed:

Byte	Contents / value
0	CTT2: Code • Index 0x93 (147): Acyclic write request is not OK.
1	CTT2: Standard error code ▶ CTT2: Standard error codes (📖 51)
2	Error code (MSB)
3	Error code
4	Error code
5	Error code (LSB) ▶ CTT2: Acyclic device error codes (📖 52)

Parameter data transfer

CTT2: Read code number

9.3 CTT2: Read code number

- Acyclic read request from the master to the slave:

Byte	Contents / value
0	CTT2: Code <ul style="list-style-type: none">• Index 0x12 (18): Acyclic read request
1	CTT2: Index <ul style="list-style-type: none">• Index 0x12 (18): Read code number
2	CTT2: Number of bytes <ul style="list-style-type: none">• Value depends on the master.

- Response from slave to master is OK:

Byte	Contents / value
0	CTT2: Code <ul style="list-style-type: none">• Index 0x52 (82): Acyclic read request is OK.
3	Index high byte
4	Index low byte
Index = 0x5FFF (code of the inverter)	
5	Subindex
6	Reserved

- Response from slave to master has failed:

Byte	Contents / value
0	CTT2: Code <ul style="list-style-type: none">• Index 0x92 (146): Acyclic read request is not OK.
1	CTT2: Standard error code <ul style="list-style-type: none">▶ CTT2: Standard error codes (📖 51)
2	Error code (MSB)
3	Error code
4	Error code
5	Error code (LSB) <ul style="list-style-type: none">▶ CTT2: Acyclic device error codes (📖 52)

Parameter data transfer

CTT2: Write code number

9.4 CTT2: Write code number

- Acyclic write request from master to slave:

Byte	Contents / value	
0	CTT2: Code <ul style="list-style-type: none">• Index 0x13 (19): Acyclic write request	
1	CTT2: Index <ul style="list-style-type: none">• Index 0x11 (17): Write code number	
2	CTT2: Number of bytes <ul style="list-style-type: none">• 0x4 (4)	
3	Index high byte	Index = 0x5FFF (code of the inverter)
4	Index low byte	
5	Subindex	
6	Reserved	

- Response from slave to master is OK:

Byte	Contents / value
0	CTT2: Code <ul style="list-style-type: none">• Index 0x53 (83): Acyclic write request is OK.• Code number was written.

- Response from slave to master has failed:

Byte	Contents / value
0	CTT2: Code <ul style="list-style-type: none">• Index 0x93 (147): Acyclic write request is not OK.
1	CTT2: Standard error code <ul style="list-style-type: none">▶ CTT2: Standard error codes (📖 51)
2	Error code (MSB)
3	Error code
4	Error code
5	Error code (LSB) <ul style="list-style-type: none">▶ CTT2: Acyclic device error codes (📖 52)

Parameter data transfer

CTT2: Block parameter transfer

9.5 CTT2: Block parameter transfer

In the case of the CTT2 block parameter transfer, parameter sets with a fixed length of 64 bytes are transmitted.



Note!

In order to guarantee that a fixed data length of 64 bytes is transmitted, all the parameters are transmitted as 32-bit values (16 x 32-bit parameters).

If required, the data lengths or formats of the parameters must be adjusted accordingly. Parameter data smaller than 32 bits are not extended to 32 bits.

9.5.1 Read mode

- Acyclic read request from the master to the slave:

Byte	Contents / value
0	CTT2: Code <ul style="list-style-type: none">• Index 0x12 (18): Acyclic read request
1	CTT2: Index <ul style="list-style-type: none">• Index 0x20 (32): Read parameter
2	CTT2: Number of bytes <ul style="list-style-type: none">• Value depends on the master.

- Response from slave to master is OK:

Byte	Contents / value
0	CTT2: Code <ul style="list-style-type: none">• Index 0x52 (82): Acyclic read request is OK.• All the parameters were read.
1	Reserved
2	Reserved
3	Reserved
4 ... 7	Double word 1 <ul style="list-style-type: none">• Value of the parameter in code C13214/1
...	...
64 ... 67	Double word 16 <ul style="list-style-type: none">• Value of the parameter in code C13214/16

Parameter data transfer

CTT2: Block parameter transfer

- Response from slave to master has failed:

Byte	Contents / value
0	CTT2: Code <ul style="list-style-type: none">• Index 0x92 (146): Acyclic read request is not OK.• Read exception list (index 0x21 (33))
1	CTT2: Standard error code ▶ CTT2: Standard error codes (📖 51)
2	Error code (MSB)
3	Error code
4	Error code
5	Error code (LSB) ▶ CTT2: Acyclic device error codes (📖 52)

- After the acyclic read request (index 0x12 (18)) has failed, the master sends error codes.
- Then the read request from master to slave with the index **0x21** (33) is repeated.
- The slave sends the parameter values in code [C13214/1...16](#) again.

Parameter data transfer

CTT2: Block parameter transfer

9.5.2 Write mode

- Acyclic write request from master to slave:

Byte	Contents / value
0	CTT2: Code <ul style="list-style-type: none">• Index 0x13 (19): Acyclic write request
1	CTT2: Index <ul style="list-style-type: none">• Index 0x28 (40): Write parameter
2	CTT2: Number of bytes <ul style="list-style-type: none">• 0x41 (65)
3	Reserved
4 ... 7	Double word 1 <ul style="list-style-type: none">• Value of the parameter in code C13213/1
...	...
64 ... 67	Double word 16 <ul style="list-style-type: none">• Value of the parameter in code C13213/16

- Response from slave to master is OK:

Byte	Contents / value
0	CTT2: Code <ul style="list-style-type: none">• Index 0x53 (83): Acyclic write request is OK.• All the parameters were written.

- Response from slave to master has failed:

Byte	Contents / value
0	CTT2: Code <ul style="list-style-type: none">• Index 0x93 (147): Acyclic write request is not OK.• Read exception list (index 0x29 (41))
1	CTT2: Standard error code <ul style="list-style-type: none">▶ CTT2: Standard error codes (📖 51)
2	Error code (MSB)
3	Error code
4	Error code
5	Error code (LSB) <ul style="list-style-type: none">▶ CTT2: Acyclic device error codes (📖 52)

- After the acyclic write request (index 0x13 (19)) has failed, the master sends error codes.
- Then the write request from master to slave with the index **0x29** (41) is repeated.
- The slave sends the parameter values in code [C13213/1...16](#) again.



Note!

Faulty writing of parameter sets can change single parameters.

Parameter data transfer

CTT2: Standard error codes

9.6 CTT2: Standard error codes

CTT2 error code	Description
0	No error / no CTT2 standard error
1	Invalid index
2	Invalid length
3	Request not executed
4	In process (request not fully completed / new trial)
5	Last acyclic request not confirmed
6	Invalid subindex
7	Command "Selective read request" is missing

Parameter data transfer

CTT2: Acyclic device error codes

9.7 CTT2: Acyclic device error codes

Error code [hex]				Description
Byte 0 (MSB)	Byte 1	Byte 2	Byte 3 (LSB)	
0x00	0x00	0x00	0x00	Transfer aborted
0x06	0x03	0x00	0x00	<ul style="list-style-type: none"> • No access rights • Invalid access • Read-only object
0x06	0x05	0x00	0x10	Invalid service
0x06	0x05	0x00	0x11	Invalid subindex
0x06	0x05	0x00	0x12	Data length too large
0x06	0x05	0x00	0x13	Data length too small
0x06	0x06	0x00	0x00	Object is no parameter
0x06	0x07	0x00	0x00	Object does not exist
0x06	0x08	0x00	0x00	Data (types) do not correspond
0x08	0x00	0x00	0x00	<ul style="list-style-type: none"> • Invalid function • Request cannot be executed • No operation
0x08	0x00	0x00	0x20	Request cannot be executed at the moment
0x08	0x00	0x00	0x21	No operation due to local control
0x08	0x00	0x00	0x22	Request cannot be executed due to the device state
0x08	0x00	0x00	0x30	<ul style="list-style-type: none"> • Value beyond the range • Parameter can only be changed when the controller is inhibited (CINH)
0x08	0x00	0x00	0x31	Parameter value too high
0x08	0x00	0x00	0x32	Parameter value too low
0x08	0x00	0x00	0x33	Value range of the (sub)parameter exceeded
0x08	0x00	0x00	0x34	Value range of the (sub)parameter too high
0x08	0x00	0x00	0x35	Value range of the (sub)parameter too low
0x08	0x00	0x00	0x36	Maximum value lower than minimum value
0x08	0x00	0x00	0x41	Communication object cannot be displayed
0x08	0x00	0x00	0x42	Process data length exceeded
0x08	0x00	0x00	0x43	General value collision
0x08	0x00	0x00	0x50	<ul style="list-style-type: none"> • Block access has failed • One or several parameter accesses within the block have failed • Read exception list for more details
0x08	0x00	0x00	0x80	Hardware error







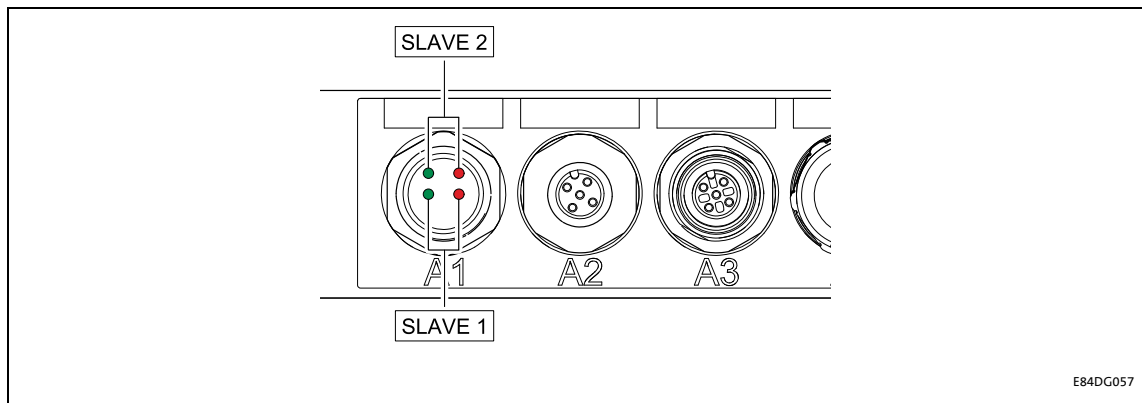

10 Diagnostics

For diagnosing troubled AS-i communication, LEDs can be mounted to the Communication Unit. The LEDs, in conjunction with a transparent cover, can be procured from Lenze.

Moreover, the current bus status can be queried via code [C13211](#) and the internal communication status can be queried via code [C13950](#).

10.1 LED status displays

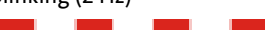

LED statuses for slave 1 and slave 2		Description
Green LEDs	Red LEDs	
Off	Off	There is no AS-i voltage.
On 	Off	Everything is alright • AS-i communication is possible.
Off	On 	The slave is switched off; data exchange with the master is not possible.
On 	On 	"No data exchange" • The Data_Exchange_Disable flag is set; data exchange with the master is not possible. • The IC is waiting for a "Write Parameter Request". • The communication monitoring reports "No data exchange" or the IC has been reset via "Watchdog IC Reset".
Blinking (2 Hz) 	On 	"No data exchange" • The slave is waiting for address assignment by the master. • Data exchange with the master is not possible.
Blinking (2 Hz) 	Blinking (2 Hz) 	Peripheral error • A signal indicating a peripheral error is pending at the FID input. • The LEDs are blinking alternately.
On 	Blinking (2 Hz) 	Fatal peripheral error with reset • Data sampling pulse = LOW for more than 44 µs

Diagnostics

Diagnostics with the »Engineer«

10.2 Diagnostics with the »Engineer«

In the »Engineer« under the **Diagnostics** tab, you will find AS-Interface diagnostics information.

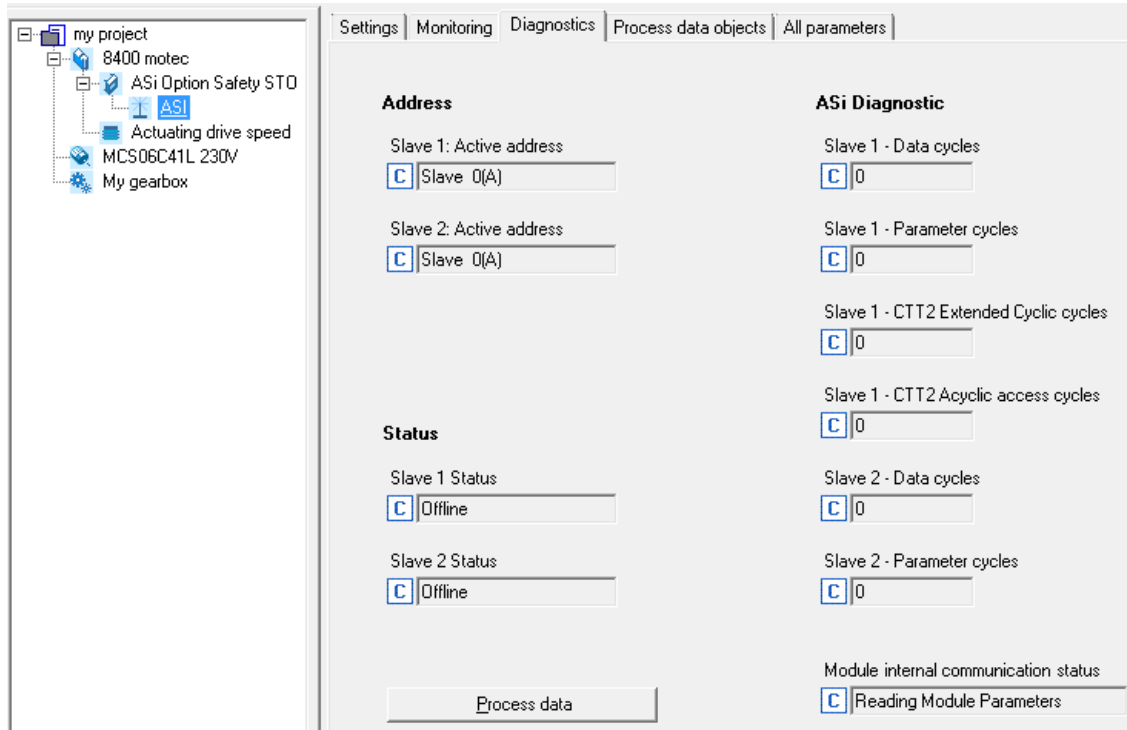

Error messages

Short overview of AS-i error messages

11 Error messages

This chapter complements the error list in the software manual and the »Engineer« online help for the Inverter Drive 8400 motec by AS-i error messages.

11.1 Short overview of AS-i error messages



Software manual/»Engineer« online help "Inverter Drive 8400 motec"

Here you will find general information on diagnostics & fault analysis and on error messages.

The following table lists all AS-Interface error messages in the numerical order of the error numbers. Furthermore, the preset error response and - if available - the parameter for setting the error response are specified.



Tip!

If you click on the cross-reference in the first column, you will get a detailed description (causes and remedies) of the corresponding error message.

Error no. [hex]	Subject area no. [dec]	Error no. [dec]	Error text	Error type (Error response)	Adjustable in
0x01bc3100	444	12544	Drive offline	1: No response	C01501/2 C01503
0x01bc5531	444	21809	Drive parameter access failure - channel 1	1: No response	
0x01bc5532	444	21810	Drive parameter access failure - channel 2	1: No response	
0x01bc6010	444	24592	Module internal/watchdog error	1: No response	C01501/1 C01503
0x01bc6011	444	24593	Drive PDO communication timeout	1: No response	C01501/2 C01503
0x01bc6100	444	24832	Module offline	1: No response	C01501/1 C01503
0x01bc6101	444	24833	Module PDO communication timeout	1: No response	
0x01bc6102	444	24834	Module parameter access failure	1: No response	
0x01bc813a	444	33082	Slave 1 data exchange timeout	1: No response	C13207/1 C13208/1
0x01bc813b	444	33083	Slave 1 CTT2 extended cyclic timeout	1: No response	C13207/2 C13208/2
0x01bc813c	444	33084	Slave 2 data exchange timeout	1: No response	C13207/3 C13208/3
0x01bc813d	444	33085	Slave 1 AS-i ASIC Profile Failure	1: No response	C13207/1 C13208/1
0x01bc813e	444	33086	Slave 2 AS-i ASIC Profile Failure	1: No response	C13207/3 C13208/3

Error messages

Possible causes and remedies

11.2 Possible causes and remedies

In this chapter, all AS-i error messages are listed in the numerical order of the error numbers. Possible causes and remedies as well as responses to the error messages are described in detail.

Drive offline [0x01bc3100]

Response (Lenze setting printed in bold)		Setting: C01501/2 / C01503 <input checked="" type="checkbox"/> adjustable response
<input checked="" type="checkbox"/> None <input type="checkbox"/> System fault <input checked="" type="checkbox"/> Fault <input type="checkbox"/> Trouble <input type="checkbox"/> Quick stop by trouble <input checked="" type="checkbox"/> Warning locked <input type="checkbox"/> Warning <input type="checkbox"/> Information		
Cause	Remedy	
<ul style="list-style-type: none"> The communication Unit is supplied with external voltage, but the Inverter Drive 8400 motec is not supplied with voltage. The Communication Unit is not connected correctly to the Drive Unit. 	<ul style="list-style-type: none"> Switch the voltage supply of the Inverter Drive 8400 motec off and on again. Check wiring and terminals. Check the internal plug connection between Communication Unit and Drive Unit. For this purpose, the Inverter Drive 8400 motec must be unscrewed. Please observe the information provided in the mounting instructions for the Communication Unit and Drive Unit! If this error continues to occur, please contact the Lenze service. (it might be necessary to replace the Communication Unit.) 	

Drive parameter access failure - channel 1 [0x01bc5531]

Response (Lenze setting printed in bold)		Setting: C01501/2 / C01503 <input checked="" type="checkbox"/> adjustable response
<input checked="" type="checkbox"/> None <input type="checkbox"/> System fault <input checked="" type="checkbox"/> Fault <input type="checkbox"/> Trouble <input type="checkbox"/> Quick stop by trouble <input checked="" type="checkbox"/> Warning locked <input type="checkbox"/> Warning <input type="checkbox"/> Information		
Cause	Remedy	
<ul style="list-style-type: none"> AS-i voltage supply interrupted. Connection between the Communication Unit and the Drive Unit defective. 	<ul style="list-style-type: none"> Check wiring and terminals. Switch the voltage supply of the Inverter Drive 8400 motec off and on again. If this error continues to occur, please contact the Lenze service. (it might be necessary to replace the Communication Unit.) 	

Drive parameter access failure - channel 2 [0x01bc5532]

Response (Lenze setting printed in bold)		Setting: C01501/2 / C01503 <input checked="" type="checkbox"/> adjustable response
<input checked="" type="checkbox"/> None <input type="checkbox"/> System fault <input checked="" type="checkbox"/> Fault <input type="checkbox"/> Trouble <input type="checkbox"/> Quick stop by trouble <input checked="" type="checkbox"/> Warning locked <input type="checkbox"/> Warning <input type="checkbox"/> Information		
Cause	Remedy	
<ul style="list-style-type: none"> AS-i voltage supply interrupted. Connection between the Communication Unit and the Drive Unit defective. 	<ul style="list-style-type: none"> Check wiring and terminals. Switch the voltage supply of the Inverter Drive 8400 motec off and on again. If this error continues to occur, please contact the Lenze service. (it might be necessary to replace the Communication Unit.) 	

Error messages

Possible causes and remedies

Module internal/watchdog error [0x01bc6010]

Response (Lenze setting printed in bold)	Setting: C01501/1 / C01503 <input checked="" type="checkbox"/> adjustable response)
<input checked="" type="checkbox"/> None <input type="checkbox"/> System fault <input checked="" type="checkbox"/> Fault <input type="checkbox"/> Trouble <input type="checkbox"/> Quick stop by trouble <input checked="" type="checkbox"/> Warning locked <input type="checkbox"/> Warning <input type="checkbox"/> Information	
Cause	Remedy
Device internal MCU error	<ul style="list-style-type: none"> • Switch the voltage supply of the Inverter Drive 8400 motec and the AS-i network off and on again. • If this error continues to occur, please contact the Lenze service. (it might be necessary to replace the Communication Unit.)

Drive PDO communication timeout [0x01bc6011]

Response (Lenze setting printed in bold)	Setting: C01501/2 / C01503 <input checked="" type="checkbox"/> adjustable response)
<input checked="" type="checkbox"/> None <input type="checkbox"/> System fault <input checked="" type="checkbox"/> Fault <input type="checkbox"/> Trouble <input type="checkbox"/> Quick stop by trouble <input checked="" type="checkbox"/> Warning locked <input type="checkbox"/> Warning <input type="checkbox"/> Information	
Cause	Remedy
Voltage supply of the Inverter Drive 8400 motec interrupted.	<ul style="list-style-type: none"> • Check wiring and terminals. • Check whether the Inverter Drive 8400 motec is addressable via the diagnostics interface. • Switch the voltage supply of the Inverter Drive 8400 motec off and on again. • If this error continues to occur, please contact the Lenze service. (it might be necessary to replace the Communication Unit.)

Module offline [0x01bc6100]

Response (Lenze setting printed in bold)	Setting: C01501/1 / C01503 <input checked="" type="checkbox"/> adjustable response)
<input checked="" type="checkbox"/> None <input type="checkbox"/> System fault <input checked="" type="checkbox"/> Fault <input type="checkbox"/> Trouble <input type="checkbox"/> Quick stop by trouble <input checked="" type="checkbox"/> Warning locked <input type="checkbox"/> Warning <input type="checkbox"/> Information	
Cause	Remedy
<ul style="list-style-type: none"> • Device internal MCU error • AS-i voltage supply interrupted. • Connection between the Communication Unit and the Drive Unit defective. 	<ul style="list-style-type: none"> • Check wiring and terminals. • Switch the voltage supply of the AS-i network off and on again. • If this error continues to occur, please contact the Lenze service. (it might be necessary to replace the Communication Unit.)

Module PDO communication timeout [0x01bc6101]

Response (Lenze setting printed in bold)	Setting: C01501/1 / C01503 <input checked="" type="checkbox"/> adjustable response)
<input checked="" type="checkbox"/> None <input type="checkbox"/> System fault <input checked="" type="checkbox"/> Fault <input type="checkbox"/> Trouble <input type="checkbox"/> Quick stop by trouble <input checked="" type="checkbox"/> Warning locked <input type="checkbox"/> Warning <input type="checkbox"/> Information	
Cause	Remedy
<ul style="list-style-type: none"> • AS-i voltage supply interrupted. • Connection between the Communication Unit and the Drive Unit defective. 	<ul style="list-style-type: none"> • Check wiring and terminals. • Switch the voltage supply of the AS-i network off and on again. • If this error continues to occur, please contact the Lenze service. (it might be necessary to replace the Communication Unit.)

Error messages

Possible causes and remedies

Module parameter access failure [0x01bc6102]

Response (Lenze setting printed in bold)	Setting: C01501/1 / C01503 (☑ adjustable response)
☑ None <input type="checkbox"/> System fault <input checked="" type="checkbox"/> Fault <input type="checkbox"/> Trouble <input type="checkbox"/> Quick stop by trouble <input checked="" type="checkbox"/> Warning locked <input type="checkbox"/> Warning <input type="checkbox"/> Information	
Cause	Remedy
<ul style="list-style-type: none"> AS-i voltage supply interrupted. Connection between the Communication Unit and the Drive Unit defective. 	<ul style="list-style-type: none"> Check wiring and terminals. Switch the voltage supply of the AS-i network off and on again. If this error continues to occur, please contact the Lenze service. (it might be necessary to replace the Communication Unit.)

Slave 1 data exchange timeout [0x01bc813a]

Response (Lenze setting printed in bold)	Setting: C13207/1 / C13208/1 (☑ adjustable response)
☑ None <input type="checkbox"/> System fault <input checked="" type="checkbox"/> Fault <input type="checkbox"/> Trouble <input type="checkbox"/> Quick stop by trouble <input checked="" type="checkbox"/> Warning locked <input type="checkbox"/> Warning <input type="checkbox"/> Information	
Cause	Remedy
<ul style="list-style-type: none"> AS-i communication / voltage supply interrupted. The monitoring time is too low. 	<ul style="list-style-type: none"> Check wiring and terminals. Switch the voltage supply of the AS-i network off and on again. Check and raise the monitoring time. Check and adjust the AS-i settings of the master. Check and adjust the AS-i profile settings of the master and the slaves.

Slave 1 CTT2 extended cyclic timeout [0x01bc813b]

Response (Lenze setting printed in bold)	Setting: C13207/2 / C13208/2 (☑ adjustable response)
☑ None <input type="checkbox"/> System fault <input checked="" type="checkbox"/> Fault <input type="checkbox"/> Trouble <input type="checkbox"/> Quick stop by trouble <input checked="" type="checkbox"/> Warning locked <input type="checkbox"/> Warning <input type="checkbox"/> Information	
Cause	Remedy
<ul style="list-style-type: none"> AS-i communication / voltage supply interrupted. The monitoring time is too low. 	<ul style="list-style-type: none"> Check wiring and terminals. Switch the voltage supply of the AS-i network off and on again. Check and raise the monitoring time. Check and adjust the CTT2 settings of the master. Check and adjust the AS-i profile settings of the master and the slaves.

Slave 2 data exchange timeout [0x01bc813c]

Response (Lenze setting printed in bold)	Setting: C13207/3 / C13208/3 (☑ adjustable response)
☑ None <input type="checkbox"/> System fault <input checked="" type="checkbox"/> Fault <input type="checkbox"/> Trouble <input type="checkbox"/> Quick stop by trouble <input checked="" type="checkbox"/> Warning locked <input type="checkbox"/> Warning <input type="checkbox"/> Information	
Cause	Remedy
<ul style="list-style-type: none"> AS-i communication / voltage supply interrupted. The monitoring time is too low. 	<ul style="list-style-type: none"> Check wiring and terminals. Switch the voltage supply of the AS-i network off and on again. Check and raise the monitoring time. Check and adjust the AS-i settings of the master. Check and adjust the AS-i profile settings of the master and the slaves.

Error messages

Possible causes and remedies

Slave 1 AS-I ASIC Profile Failure [0x01bc813d]

Response (Lenze setting printed in bold)	Setting: C13207/1 / C13208/1 (<input checked="" type="checkbox"/> adjustable response)
<input checked="" type="checkbox"/> None <input type="checkbox"/> System fault <input checked="" type="checkbox"/> Fault <input type="checkbox"/> Trouble <input type="checkbox"/> Quick stop by trouble <input checked="" type="checkbox"/> Warning locked <input type="checkbox"/> Warning <input type="checkbox"/> Information	
Cause	Remedy
<ul style="list-style-type: none">• The AS-i profile read by slave 1 (via MCU) does not correspond to the AS-i profile 7.A.5• Module-internal switching error• AS-i ASIC error	<ul style="list-style-type: none">• Check voltage supply, wiring and terminals.• Switch the voltage supply of the AS-i network off and on again.• If this error continues to occur, please contact the Lenze service. (it might be necessary to replace the Communication Unit.)

Slave 2 AS-I ASIC Profile Failure [0x01bc813e]

Response (Lenze setting printed in bold)	Setting: C13207/3 / C13208/3 (<input checked="" type="checkbox"/> adjustable response)
<input checked="" type="checkbox"/> None <input type="checkbox"/> System fault <input checked="" type="checkbox"/> Fault <input type="checkbox"/> Trouble <input type="checkbox"/> Quick stop by trouble <input checked="" type="checkbox"/> Warning locked <input type="checkbox"/> Warning <input type="checkbox"/> Information	
Cause	Remedy
<ul style="list-style-type: none">• The AS-i profile read by slave 2 (via MCU) does not correspond to the AS-i profile 7.A.E• Module-internal switching error• AS-i ASIC error	<ul style="list-style-type: none">• Check voltage supply, wiring and terminals.• Switch the voltage supply of the AS-i network off and on again.• If this error continues to occur, please contact the Lenze service. (it might be necessary to replace the Communication Unit.)

Parameter reference

Communication-relevant parameters of the operating system

12 Parameter reference

This chapter supplements the parameter list and the table of attributes in the software manual and in the »Engineer« online help for the Inverter Drive 8400 motec by the parameters for AS-i communication.

12.1 Communication-relevant parameters of the operating system



Software manual/»Engineer« online help "Inverter Drive 8400 motec"

Here you will find general information on parameters.

This chapter lists the communication-relevant parameters of the 8400 motec operating system in numerically ascending order.

C01501

Parameter Name: C01501 Response in case of communication fault with MCI		Data type: UNSIGNED_8 Index: 23074 = 0x5A22
Setting the response to a communication fault or an incompatible communication unit		
Selection list		
0	No response	
1	Fault	
4	Warning Locked	
Subcodes	Lenze setting	Info
C01501/1	1: No response	Resp. to MCI fault 1 • Response to a communication fault.
C01501/2	1: No response	Resp. to MCI fault 2 • Response to an incompatible communication unit.
<input checked="" type="checkbox"/> Read access <input checked="" type="checkbox"/> Write access <input type="checkbox"/> CINH <input type="checkbox"/> PLC STOP <input type="checkbox"/> No transfer <input type="checkbox"/> COM <input type="checkbox"/> MOT Scaling factor: 1		

C01503

Parameter Name: C01503 MCI timeout		Data type: UNSIGNED_16 Index: 23072 = 0x5A20
Setting range (min. value unit max. value)		
0	ms	1000
Subcodes	Lenze setting	Info
C01503/1	200 ms	MCI timeout
<input checked="" type="checkbox"/> Read access <input checked="" type="checkbox"/> Write access <input type="checkbox"/> CINH <input type="checkbox"/> PLC STOP <input type="checkbox"/> No transfer <input type="checkbox"/> COM <input type="checkbox"/> MOT Scaling factor: 1		

Parameter reference

Parameters relevant for AS-i communication

12.2 Parameters relevant for AS-i communication

This chapter lists the AS-i parameters of the communication unit in numerically ascending order.

C13200

Parameter Name: C13200 Active address		Data type: UNSIGNED_8 Index: 11375 = 0x2C6F
Display of the active address of the inverter in the AS-i network ▶ Addressing the AS-i slaves (📖 26)		
Selection list (read only)		Info
0	Slave 0(A)	
...	...	
31	Slave 31(A)	
32	Slave 0(B) - invalid	
33	Slave 1(B)	
...	...	
63	Slave 31(B)	
64	Slave not active	An error message is generated when a slave is deactivated.
Subcodes		Info
C13200/1		Slave 1: Active address
C13200/2		Slave 2: Active address
<input checked="" type="checkbox"/> Read access <input type="checkbox"/> Write access <input type="checkbox"/> CINH <input type="checkbox"/> PLC STOP <input checked="" type="checkbox"/> No transfer <input type="checkbox"/> PDO_MAP_RX <input type="checkbox"/> PDO_MAP_TX <input checked="" type="checkbox"/> COM <input type="checkbox"/> MOT		

C13202

Parameter Name: C13202 Slave address EPM value		Data type: UNSIGNED_8 Index: 11373 = 0x2C6D
Selection of the address of the inverter in the AS-i network ▶ Addressing the AS-i slaves (📖 26)		
Selection list (Lenze setting printed in bold)		
0	Slave 0(A)	
...	...	
31	Slave 31(A)	
32	Slave 0(B) - invalid	
33	Slave 1(B)	
...	...	
63	Slave 31(B)	
64	Slave not active	An error message is generated when a slave is deactivated.
Subcodes		Info
C13202/1	0	Slave 1: Address EPM value
C13202/2	0	Slave 2: Address EPM value
<input checked="" type="checkbox"/> Read access <input checked="" type="checkbox"/> Write access <input type="checkbox"/> CINH <input type="checkbox"/> PLC STOP <input type="checkbox"/> No transfer <input type="checkbox"/> PDO_MAP_RX <input type="checkbox"/> PDO_MAP_TX <input checked="" type="checkbox"/> COM <input type="checkbox"/> MOT		

Parameter reference

Parameters relevant for AS-i communication

C13204

Parameter Name: C13204 Override Slave Addresses		Data type: UNSIGNED_8 Index: 11371 = 0x2C6B
Selection list (Lenze setting printed in bold)		
0	Off / ready	
1	On / start	
2	In progress	
3	Action failed	
4	Action cancelled	
5	No access	
<input checked="" type="checkbox"/> Read access <input checked="" type="checkbox"/> Write access <input type="checkbox"/> CINH <input type="checkbox"/> PLC STOP <input type="checkbox"/> No transfer <input type="checkbox"/> PDO_MAP_RX <input type="checkbox"/> PDO_MAP_TX <input type="checkbox"/> COM <input type="checkbox"/> MOT		

C13205

Parameter Name: C13205 Override of slave addresses during initialisation		Data type: UNSIGNED_8 Index: 11370 = 0x2C6A
Selection list (Lenze setting printed in bold)		
0	Disable	
1	Enable	
<input checked="" type="checkbox"/> Read access <input checked="" type="checkbox"/> Write access <input type="checkbox"/> CINH <input type="checkbox"/> PLC STOP <input type="checkbox"/> No transfer <input type="checkbox"/> PDO_MAP_RX <input type="checkbox"/> PDO_MAP_TX <input type="checkbox"/> COM <input type="checkbox"/> MOT		

C13206

Parameter Name: C13206 Slave profiles		Data type: UNSIGNED_16 Index: 11369 = 0x2C69
Value is bit-coded:		
Bit 0	ID_Code_2_Bit0	
Bit 1	ID_Code_2_Bit1	
Bit 2	ID_Code_2_Bit2	
Bit 3	ID_Code_2_Bit3	
Bit 4	ID_Code_1_Bit0	
Bit 5	ID_Code_1_Bit1	
Bit 6	ID_Code_1_Bit2	
Bit 7	ID_Code_1_Bit3	
Bit 8	ID_Code_Bit0	
Bit 9	ID_Code_Bit1	
Bit 10	ID_Code_Bit2	
Bit 11	ID_Code_Bit3	
Bit 12	IO_Configuration_Bit0	
Bit 13	IO_Configuration_Bit1	
Bit 14	IO_Configuration_Bit2	
Bit 15	IO_Configuration_Bit3	
Subcodes		Info
C13206/1		Slave 1 Profile
C13206/2		Slave 2 Profile
<input checked="" type="checkbox"/> Read access <input type="checkbox"/> Write access <input type="checkbox"/> CINH <input type="checkbox"/> PLC STOP <input type="checkbox"/> No transfer <input type="checkbox"/> PDO_MAP_RX <input type="checkbox"/> PDO_MAP_TX <input type="checkbox"/> COM <input type="checkbox"/> MOT		

Parameter reference

Parameters relevant for AS-i communication

C13207

Parameter Name: C13207 Response in case of communication fault		Data type: UNSIGNED_8 Index: 11368 = 0x2C68
The response set here is triggered if the AS-i node does not receive a message from the master within the monitoring time (C13208) or detects that it has exited the DATA_EXCHANGE status. A change in the monitoring response becomes immediately effective.		
Selection list (Lenze setting printed in bold)		
0	No response	
1	Fault	
4	Warning Locked	
Subcodes	Lenze setting	Info
C13207/1	1	Slave 1 communication timeout
C13207/2	1	Slave 1 communication timeout - CTT2 extended cyclic
C13207/3	1	Slave 2 communication timeout
<input checked="" type="checkbox"/> Read access <input checked="" type="checkbox"/> Write access <input type="checkbox"/> CINH <input type="checkbox"/> PLC STOP <input checked="" type="checkbox"/> No transfer <input type="checkbox"/> PDO_MAP_RX <input type="checkbox"/> PDO_MAP_TX <input checked="" type="checkbox"/> COM <input type="checkbox"/> MOT		

C13208

Parameter Name: C13208 AS-i monitoring times		Data type: UNSIGNED_16 Index: 11367 = 0x2C67
If the DATA_EXCHANGE status is exited, the response parameterised in C13207/1...3 is carried out when the time set here for the data exchange has elapsed.		
<ul style="list-style-type: none"> • The value "65535" is used to deactivate the monitoring. • A change in the monitoring is immediately effective. 		
Setting range (min. value unit max. value)		
0	ms	65535
Subcodes	Lenze setting	Info
C13208/1	3000 ms	Slave 1 monitoring time
C13208/2	3000 ms	Slave 1 monitoring time - CTT2 extended cyclic
C13208/3	3000 ms	Slave 2 monitoring time
<input checked="" type="checkbox"/> Read access <input checked="" type="checkbox"/> Write access <input type="checkbox"/> CINH <input type="checkbox"/> PLC STOP <input type="checkbox"/> No transfer <input type="checkbox"/> PDO_MAP_RX <input type="checkbox"/> PDO_MAP_TX <input type="checkbox"/> COM <input type="checkbox"/> MOT		

C13210

Parameter Name: C13210 AS-i Bus transaction counter		Data type: UNSIGNED_16 Index: 11365 = 0x2C65
Display of AS-i transactions		
Display range (min. value unit max. value)		
0		65535
Subcodes	Info	
C13210/1	Slave 1 - Data cycles	
C13210/2	Slave 1 - Parameter cycles	
C13210/3	Slave 1 - CTT2 extended cyclic cycles	
C13210/4	Slave 1 - CTT2 acyclic access cycles	
C13210/5	Slave 2 - Data cycles	
C13210/6	Slave 2 - Parameter cycles	
<input checked="" type="checkbox"/> Read access <input type="checkbox"/> Write access <input type="checkbox"/> CINH <input type="checkbox"/> PLC STOP <input type="checkbox"/> No transfer <input type="checkbox"/> PDO_MAP_RX <input type="checkbox"/> PDO_MAP_TX <input checked="" type="checkbox"/> COM <input type="checkbox"/> MOT		

Parameter reference

Parameters relevant for AS-i communication

C13211

Parameter Name: C13211 bus status		Data type: UNSIGNED_8 Index: 11364 = 0x2C64
Display of the current AS-i bus status		
Selection list (read only)		Info
0	Offline	
1	Initialisation	
2	Online	
3	Initialisation failed	
4	Not accessible	
5	Disabled at 0 address	
Subcodes		Info
C13211/1		Slave 1 Status
C13211/2		Slave 2 Status
<input checked="" type="checkbox"/> Read access <input type="checkbox"/> Write access <input type="checkbox"/> CINH <input type="checkbox"/> PLC STOP <input checked="" type="checkbox"/> No transfer <input type="checkbox"/> PDO_MAP_RX <input type="checkbox"/> PDO_MAP_TX <input checked="" type="checkbox"/> COM <input type="checkbox"/> MOT		

C13213

Parameter Name: C13213 CTT2 block parameter transfer: Write parameter block configuration		Data type: INTEGER_32 Index: 11362 = 0x2C62
▶ CTT2 block parameter transfer Write mode (🔗 50)		
Setting range (min. value unit max. value)		
0.000		16000.000
Subcodes	Lenze setting	Info
C13213/1	11.000	WriteParamBlock:Index_1
C13213/2	12.000	WriteParamBlock:Index_2
C13213/3	13.000	WriteParamBlock:Index_3
C13213/4	15.000	WriteParamBlock:Index_4
C13213/5	16.000	WriteParamBlock:Index_5
C13213/6	22.000	WriteParamBlock:Index_6
C13213/7	39.001	WriteParamBlock:Index_7
C13213/8	39.002	WriteParamBlock:Index_8
C13213/9	39.003	WriteParamBlock:Index_9
C13213/10	87.000	WriteParamBlock:Index_10
C13213/11	105.000	WriteParamBlock:Index_11
C13213/12	120.000	WriteParamBlock:Index_12
C13213/13	123.000	WriteParamBlock:Index_13
C13213/14	129.000	WriteParamBlock:Index_14
C13213/15	130.000	WriteParamBlock:Index_15
C13213/16	131.000	WriteParamBlock:Index_16
<input checked="" type="checkbox"/> Read access <input checked="" type="checkbox"/> Write access <input type="checkbox"/> CINH <input type="checkbox"/> PLC STOP <input type="checkbox"/> No transfer <input type="checkbox"/> PDO_MAP_RX <input type="checkbox"/> PDO_MAP_TX <input type="checkbox"/> COM <input type="checkbox"/> MOT Scaling factor: 1000		

Parameter reference

Parameters relevant for AS-i communication

C13214

Parameter Name: C13214 CTT2 block parameter transfer: Read parameter block configuration		Data type: INTEGER_32 Index: 11361 = 0x2C61
▶ CTT2 block parameter transfer Read mode (📖 48)		
Setting range (min. value unit max. value)		
0.000		16000.000
Subcodes	Lenze setting	Info
C13214/1	50.000	ReadParamBlock:Index_1
C13214/2	51.000	ReadParamBlock:Index_2
C13214/3	53.000	ReadParamBlock:Index_3
C13214/4	54.000	ReadParamBlock:Index_4
C13214/5	58.000	ReadParamBlock:Index_5
C13214/6	61.000	ReadParamBlock:Index_6
C13214/7	64.001	ReadParamBlock:Index_7
C13214/8	98.000	ReadParamBlock:Index_8
C13214/9	133.000	ReadParamBlock:Index_9
C13214/10	137.000	ReadParamBlock:Index_10
C13214/11	150.000	ReadParamBlock:Index_11
C13214/12	155.000	ReadParamBlock:Index_12
C13214/13	158.000	ReadParamBlock:Index_13
C13214/14	443.001	ReadParamBlock:Index_14
C13214/15	444.001	ReadParamBlock:Index_15
C13214/16	179.000	ReadParamBlock:Index_16
<input checked="" type="checkbox"/> Read access <input checked="" type="checkbox"/> Write access <input type="checkbox"/> CINH <input type="checkbox"/> PLC STOP <input type="checkbox"/> No transfer <input type="checkbox"/> PDO_MAP_RX <input type="checkbox"/> PDO_MAP_TX <input type="checkbox"/> COM <input type="checkbox"/> MOT Scaling factor: 1000		

C13220

Parameter Name: C13220 Display: Last data to master		Data type: UNSIGNED_16 Index: 11355 = 0x2C5B
Display of the last data transmitted from the communication unit to the master.		
Value is bit-coded:		
Bit 0	D0	
Bit 1	D1	
Bit 2	D2	
Bit 3	D3	
Bit 4	PR0	
Bit 5	PR1	
Bit 6	PR2	
Bit 7	PR3	
Bit 8	Reserved	
...	...	
Bit 15	Reserved	
Subcodes		Info
C13220/1		Last data to master from slave 1
C13220/2		Last data to master from slave 2
<input checked="" type="checkbox"/> Read access <input type="checkbox"/> Write access <input type="checkbox"/> CINH <input type="checkbox"/> PLC STOP <input type="checkbox"/> No transfer <input type="checkbox"/> PDO_MAP_RX <input type="checkbox"/> PDO_MAP_TX <input type="checkbox"/> COM <input type="checkbox"/> MOT		

Parameter reference

Parameters relevant for AS-i communication

C13221

Parameter Name: C13221 Display: Last data from master		Data type: UNSIGNED_16 Index: 11354 = 0x2C5A
Display of the last data transmitted from the master to the communication unit.		
Value is bit-coded:		
Bit 0	D0	
Bit 1	D1	
Bit 2	D2	
Bit 3	D3	
Bit 4	PR0	
Bit 5	PR1	
Bit 6	PR2	
Bit 7	PR3	
Bit 8	Reserved	
...	...	
Bit 15	Reserved	
Subcodes		Info
C13221/1		Last data from master to slave 1
C13221/2		Last data from master to slave 2
<input checked="" type="checkbox"/> Read access <input type="checkbox"/> Write access <input type="checkbox"/> CINH <input type="checkbox"/> PLC STOP <input type="checkbox"/> No transfer <input type="checkbox"/> PDO_MAP_RX <input type="checkbox"/> PDO_MAP_TX <input type="checkbox"/> COM <input type="checkbox"/> MOT		

C13852

Parameter Name: C13852 All words to standard device		Data type: UNSIGNED_16 Index: 10723 = 0x29E3
Display of process data words 1 ... 8 which are transmitted from the communication unit to the drive unit. Subcodes 1 ... 8 display all the process data words from the communication unit.		
Display range (min. value unit max. value)		
0		65535
Subcodes		Info
C13852/1		Word 1 of process data from module to standard device
...		...
C13852/8		Word 8 of process data from module to standard device
<input checked="" type="checkbox"/> Read access <input type="checkbox"/> Write access <input type="checkbox"/> CINH <input type="checkbox"/> PLC STOP <input checked="" type="checkbox"/> No transfer <input type="checkbox"/> PDO_MAP_RX <input type="checkbox"/> PDO_MAP_TX <input type="checkbox"/> COM <input type="checkbox"/> MOT		

C13853

Parameter Name: C13853 All words from standard device		Data type: UNSIGNED_16 Index: 10722 = 0x29E2
Display of process data words 1 ... 8 which are transmitted from the drive unit to the communication unit. Subcodes 1 ... 8 display all the process data words from the drive unit.		
Display range (min. value unit max. value)		
0		65535
Subcodes		Info
C13853/1		Word 1 process data from standard device to module
...		...
C13853/8		Word 8 of process data from standard device to module
<input checked="" type="checkbox"/> Read access <input type="checkbox"/> Write access <input type="checkbox"/> CINH <input type="checkbox"/> PLC STOP <input checked="" type="checkbox"/> No transfer <input type="checkbox"/> PDO_MAP_RX <input type="checkbox"/> PDO_MAP_TX <input type="checkbox"/> COM <input type="checkbox"/> MOT		

Parameter reference

Parameters relevant for AS-i communication

C13900

Parameter Name: C13900 Firmware product type	Data type: VISIBLE_STRING Index: 10675 = 0x29B3
Display of the product type (string with a length of 8 bytes) • The following identification code is displayed: "E84DGFC".	
<input checked="" type="checkbox"/> Read access <input type="checkbox"/> Write access <input type="checkbox"/> CINH <input type="checkbox"/> PLC STOP <input type="checkbox"/> No transfer <input type="checkbox"/> PDO_MAP_RX <input type="checkbox"/> PDO_MAP_TX <input type="checkbox"/> COM <input type="checkbox"/> MOT	

C13901

Parameter Name: C13901 Firmware compilation date	Data type: VISIBLE_STRING Index: 10674 = 0x29B2
Display of the compilation date of the firmware (string with a length of 20 bytes) • The date ("MMM DD YYYY") and time ("hh:mm:ss") are output, e.g. "Mar 21 2005 12:31:21".	
<input checked="" type="checkbox"/> Read access <input type="checkbox"/> Write access <input type="checkbox"/> CINH <input type="checkbox"/> PLC STOP <input type="checkbox"/> No transfer <input type="checkbox"/> PDO_MAP_RX <input type="checkbox"/> PDO_MAP_TX <input type="checkbox"/> COM <input type="checkbox"/> MOT	

C13902

Parameter Name: C13902 Firmware version	Data type: VISIBLE_STRING Index: 10673 = 0x29B1
Display of the firmware version (string with a length of 5 bytes) • An identification code is displayed, e.g. "00.80".	
<input checked="" type="checkbox"/> Read access <input type="checkbox"/> Write access <input type="checkbox"/> CINH <input type="checkbox"/> PLC STOP <input type="checkbox"/> No transfer <input type="checkbox"/> PDO_MAP_RX <input type="checkbox"/> PDO_MAP_TX <input type="checkbox"/> COM <input type="checkbox"/> MOT	

C13950

Parameter Name: C13950 Internal communication status	Data type: UNSIGNED_8 Index: 10625 = 0x2981
Display of the internal status of the communication unit	
Selection list (read only)	Info
0	Module not initialised
1	Module ready for initialisation
2	Reading module parameters
3	Module parameters have been read
4	Initialisation of external protocol
5	Online
6	Module timeout
7	'Stay Alive' condition
<input checked="" type="checkbox"/> Read access <input type="checkbox"/> Write access <input type="checkbox"/> CINH <input type="checkbox"/> PLC STOP <input type="checkbox"/> No transfer <input type="checkbox"/> PDO_MAP_RX <input type="checkbox"/> PDO_MAP_TX <input type="checkbox"/> COM <input type="checkbox"/> MOT	

Parameter reference

Table of attributes

12.3 Table of attributes

The table of attributes contains information required for a communication with the inverter via parameters.

How to read the table of attributes:

Column		Meaning	Entry		
Code		Parameter name	Cxxxxx		
Name		Parameter short text (display text)	Text		
Index	dec	Index under which the parameter is addressed. The subindex for array variables corresponds to the Lenze subcode number.	24575 - Lenze code number	Is only required for access via a bus system.	
	hex		0x5FFF - Lenze code number		
Data	DS	Data structure	E	Single variable (only one parameter element)	
			A	Array variable (several parameter elements)	
	DA	Number of array elements (subcodes)	Number		
	DT	Data type	BITFIELD_8	1 byte, bit-coded	
			BITFIELD_16	2 bytes, bit-coded	
			BITFIELD_32	4 bytes, bit-coded	
			INTEGER_8	1 byte, with sign	
			INTEGER_16	2 bytes with sign	
			INTEGER_32	4 bytes, with sign	
			UNSIGNED_8	1 byte without sign	
			UNSIGNED_16	2 bytes without sign	
			UNSIGNED_32	4 bytes, without sign	
			VISIBLE_STRING	ASCII string	
OCTET_STRING					
Factor	Factor for data transmission via a bus system, depending on the number of decimal positions	Factor	1 = no decimal positions 10 = 1 decimal position 100 = 2 decimal positions 1000 = 3 decimal positions		
Access	R	Read access	<input checked="" type="checkbox"/> Reading permitted		
	W	Write access	<input checked="" type="checkbox"/> Writing permitted		
	CINH	Controller inhibit required	<input checked="" type="checkbox"/> Writing is only possible if controller inhibit is set		

Parameter reference

Table of attributes

Table of attributes

Code	Name	Index		Data				Access		
		dec	hex	DS	DA	Data type	Factor	R	W	CINH
C13200	Active address	11375	0x2C6F	A	2	UNSIGNED_8	1	<input checked="" type="checkbox"/>		
C13202	Slave address EPM value	11373	0x2C6D	A	2	UNSIGNED_8	1	<input checked="" type="checkbox"/>	<input checked="" type="checkbox"/>	
C13204	Override slave addresses	11371	0x2C6B	E	1	UNSIGNED_8	1	<input checked="" type="checkbox"/>	<input checked="" type="checkbox"/>	
C13205	Override of slave addresses during initialisation	11370	0x2C6A	E	1	UNSIGNED_8	1	<input checked="" type="checkbox"/>	<input checked="" type="checkbox"/>	
C13206	Slave profiles	11369	0x2C69	A	2	UNSIGNED_16		<input checked="" type="checkbox"/>		
C13207	Response in case of communication fault	11368	0x2C68	A	3	UNSIGNED_8	1	<input checked="" type="checkbox"/>	<input checked="" type="checkbox"/>	
C13208	AS-i monitoring times	11367	0x2C67	A	3	UNSIGNED_16	1	<input checked="" type="checkbox"/>	<input checked="" type="checkbox"/>	
C13210	AS-i bus transaction counter	11365	0x2C65	A	6	UNSIGNED_16	1	<input checked="" type="checkbox"/>		
C13211	Bus status	11364	0x2C64	A	2	UNSIGNED_8	1	<input checked="" type="checkbox"/>		
C13213	CTT2 block parameter transfer: Write parameter block configuration	11362	0x2C62	A	16	INTEGER_32	1000	<input checked="" type="checkbox"/>	<input checked="" type="checkbox"/>	
C13214	CTT2 block parameter transfer: Read parameter block configuration	11361	0x2C61	A	16	INTEGER_32	1000	<input checked="" type="checkbox"/>	<input checked="" type="checkbox"/>	
C13220	Display: Last data to master	11355	0x2C5B	A	2	UNSIGNED_16		<input checked="" type="checkbox"/>		
C13221	Display: Last data from master	11354	0x2C5A	A	2	UNSIGNED_16		<input checked="" type="checkbox"/>		
C13852	All words to standard device	10723	0x29E3	A	8	UNSIGNED_16	1	<input checked="" type="checkbox"/>		
C13853	All words from standard device	10722	0x29E2	A	8	UNSIGNED_16	1	<input checked="" type="checkbox"/>		
C13900	Firmware Product Type	10675	0x29B3	E	1	VISIBLE_STRING		<input checked="" type="checkbox"/>		
C13901	Firmware Compilation Date	10674	0x29B2	E	1	VISIBLE_STRING		<input checked="" type="checkbox"/>		
C13902	Firmware Version	10673	0x29B1	E	1	VISIBLE_STRING		<input checked="" type="checkbox"/>		
C13950	Module internal communication status	10625	0x2981	E	1	UNSIGNED_8	1	<input checked="" type="checkbox"/>		

Index

A

Accessing process data [39](#)
Active address (C13200) [61](#)
Acyclic parameter data channel [17](#)
Addressing the AS-i slaves [26](#)
All words from standard device (C13853) [66](#)
All words to standard device (C13852) [66](#)
Application as directed [12](#)
Application notes (representation) [9](#)
Approvals [16](#)
AS-i: monitoring times (C13208) [63](#)
AS-i bus transaction counter (C13210) [63](#)
AS-i concept of the Communication Unit [33](#)
AS-i connection [22](#)
AS-i error messages: Causes and remedies [56](#)
AS-i error messages (short overview) [55](#)
AS-i profile 7.A.5 [34](#)
AS-i profile 7.A.E [36](#)

B

Baud rate [16](#)
Before initial switch-on [24](#)
Broadcast call of the master [29](#)
Bus access method [29](#)
Bus status (C13211) [64](#)
Bus termination [16](#)

C

C01501 | Resp. to communication error with MCI [60](#)
C01503 | MCI timeout [60](#)
C13200 | Active address [61](#)
C13202 | Slave address EPM value [61](#)
C13204 | Override Slave Addresses [62](#)
C13205 | Override of slave addresses during initialisation [62](#)
C13206 | Slave profiles [62](#)
C13207 | Response in case of communication fault [63](#)
C13208 | AS-i: monitoring times [63](#)
C13210 | AS-i bus transaction counter [63](#)
C13211 | Bus status [64](#)
C13213 | CTT2 block parameter transfer: Write parameter block configuration [64](#)
C13214 | CTT2 block parameter transfer: Read parameter block configuration [65](#)
C13220 | Display: Last data to master [65](#)
C13221 | Display: Last data from master [66](#)
C13852 | All words to standard device [66](#)
C13853 | All words from standard device [66](#)
C13900 | Firmware Product Type [67](#)

C13901 | Firmware Compilation Date [67](#)
C13902 | Firmware Version [67](#)
C13950 | Module internal communication status [67](#)
Cable length [16](#)
Codes [60](#)
Commissioning [24](#)
Communication medium [16](#)
Communication profile [16](#)
Communication time [18](#)
Communication-relevant parameters of the operating system [60](#)
Configuring the master [25](#)
Conformities [16](#)
Connections [14](#)
Conventions [7](#)
Conventions used [7](#)
CTT2
 Acyclic device error codes [52](#)
 Block parameter transfer read mode [48](#)
 Block parameter transfer write mode [50](#)
 Read code [46](#)
 Read parameter value [44](#)
 Standard error codes [51](#)
 Write code [47](#)
 Write parameter value [45](#)
CTT2 block parameter transfer
 Read parameter block configuration (C13214) [65](#)
 Write parameter block configuration (C13213) [64](#)
Cycle [31](#)
Cycle time [16](#), [31](#)
Cyclic parameter data channel [17](#)

D

Data transfer [29](#)
Data transmission slave 1 (AS-i profile 7.A.5) [34](#)
Data transmission slave 2 (AS-i profile 7.A.E) [36](#)
Device and application-specific safety instructions [11](#)
Device profiles [17](#), [33](#)
Device protection [11](#)
Diagnostics [53](#)
Diagnostics via parameter ports (parameter echo) [37](#)
Diagnostics with the »Engineer« [54](#)
Digital inputs, available [16](#)
Display: Last data to master (C13220) [65](#)
Document history [6](#)
Drive offline (error message) [56](#)
Drive parameter access failure - channel 1 (error message) [56](#)
Drive parameter access failure - channel 2 (error message) [56](#)
Drive PDO communication timeout (error message) [57](#)

Index

E

- Electrical installation [21](#)
- E-mail to Lenze [73](#)
- Error messages [55](#)
 - Causes and remedies [56](#)
- Error messages (short overview) [55](#)
- Error messages (slave 2) [37](#)
- Error number
 - 0x01bc3100 [56](#)
 - 0x01bc5531 [56](#)
 - 0x01bc5532 [56](#)
 - 0x01bc6010 [57](#)
 - 0x01bc6011 [57](#)
 - 0x01bc6100 [57](#)
 - 0x01bc6101 [57](#)
 - 0x01bc6102 [58](#)
 - 0x01bc813a [58](#)
 - 0x01bc813b [58](#)
 - 0x01bc813c [58](#)
 - 0x01bc813d [59](#)
 - 0x01bc813e [59](#)
- Establishing communication [28](#)
- Extended process image for slave 1 [35](#)

F

- Feedback to Lenze [73](#)
- Firmware Compilation Date (C13901) [67](#)
- Firmware Product Type (C13900) [67](#)
- Firmware Version (C13902) [67](#)

G

- General data [16](#)
- General safety and application notes [10](#)

H

- How to configure the host (master) [25](#)
- How to configure the port interconnection in the »Engineer« [40](#)

I

- I/O configuration slave 1 (AS-i profile 7.A.5) [34](#)
- I/O configuration slave 2 (AS-i profile 7.A.E) [36](#)
- Initial switch-on [28](#)
- Installation [19](#)
- Interface [16](#)
- Interfaces [14](#)

L

- Last data from master (C13221) [66](#)
- LED status displays [53](#)

M

- Make the I/O configuration (port interconnection) [40](#)
- Master call [30](#)
- MCI timeout (C01503) [60](#)
- Mechanical installation [20](#)
- Messages [29](#)
- Module internal communication status (C13950) [67](#)
- Module internal/watchdog error (error message) [57](#)
- Module offline (error message) [57](#)
- Module parameter access failure (error message) [58](#)
- Module PDO communication timeout (error message) [57](#)

N

- Network topology [16](#)
- Node address area [16](#)
- Notes used [9](#)
- Number of nodes [16](#)
- Number of slaves [16](#)

O

- Operating conditions [16](#)
- Override of slave addresses during initialisation (C13205) [62](#)
- Override Slave Addresses (C13204) [62](#)

P

- Parameter [60](#)
- Parameter bits [37](#)
- Parameter data [43](#)
- Parameter data transfer [43](#)
- Parameters for setting the AS-i communication [27](#)
- Parameters relevant for AS-i communication [61](#)
- PDO mapping [39](#)
- Port interconnection of process data objects (PDO) [40](#)
- Process data [38](#)
- Process data objects (I/O configuration) [40](#)
- Process data transfer [38](#)
- Process image (extended) for slave 1 [35](#)
- Process image, A/B technique [17](#)
- Process image, standard [17](#)
- Processing time [18](#)
- Product description [12](#)
- Product features [13](#)
- Protocol data [17](#)

R

- Residual hazards [11](#)
- Resp. to communication error with MCI (C01501) [60](#)
- Response in case of communication fault (C13207) [63](#)
- Response time [31](#)

Index

S

Safety instructions [10](#)
Safety instructions (representation) [9](#)
Screenshots [5](#)
Setting the AS-i communication in the »Engineer« [26](#)
Settings for AS-i communication in the »Engineer« [26](#)
Slave 1 AS-I ASIC Profile Failure (error message) [59](#)
Slave 1 CTT2 extended cyclic timeout (error message) [58](#)
Slave 1 Data exchange timeout (error message) [58](#)
Slave 2 AS-I ASIC Profile Failure (error message) [59](#)
Slave 2 Data exchange timeout (error message) [58](#)
Slave Address EPM value (C13202) [61](#)
Slave profiles (C13206) [62](#)
Slave response [30](#)
Specifications [16](#)
Standards [16](#)
Status displays (LEDs) [53](#)
Synchronisation [32](#)
System error messages [55](#)

T

Table of attributes [68](#)
Target group [5](#)
Technical data [16](#)
Terminology used [8](#)
Terms [8](#)
Type of node [16](#)

U

User data length [17](#), [25](#)
Using the communication module [12](#)

V

Validity of the documentation [5](#)
Versions [13](#)
Voltage supply [16](#), [23](#)

W

Warnings (slave 2) [37](#)

FEEDBACK



Your opinion is important to us

These instructions were created to the best of our knowledge and belief to give you the best possible support for handling our product.

If you have suggestions for improvement, please e-mail us to:

feedback-docu@Lenze.de

Thank you for your support.

Your Lenze documentation team



Lenze Drives GmbH

Postfach 10 13 52

D-31763 Hameln

Germany

☎ +49 (0)51 54 / 82-0

📠 +49 (0)51 54 / 82-28 00

✉ Lenze@Lenze.de

🌐 www.Lenze.com

Service

Lenze Service GmbH

Breslauer Straße 3

D-32699 Extertal

Germany

☎ 00 80 00 / 24 4 68 77 (24 h helpline)

📠 +49 (0)51 54 / 82-11 12

✉ Service@Lenze.de